



DECOMASTER

ИНТЕРЬЕРНЫЙ ДЕКОР

The background of the advertisement features a dark, textured surface. On the left, a large, ornate frame with a dark, cracked, and aged appearance is visible. To the right, a smaller, more refined frame with a metallic, possibly silver or gold, finish is shown. This inner frame contains a dark, intricate artwork with swirling, organic patterns in shades of brown and purple. The overall aesthetic is one of luxury and classical interior design.

БАГЕТ

[WWW.DECOMASTER.SU](http://WWW.DECOMASTER.SU)



Компания DECOMASTER более 20 лет работает на Российском рынке интерьерного декора и отделочных материалов

#### DECOMASTER СЕГОДНЯ:

- Производитель высокотехнологичных трендовых изделий и эксперт в области комплексных интерьерных решений.
- Высокий уровень дизайна на уровне искусства. Авторская продукция.
- Постоянное обновление ассортимента.
- Сбалансированное предложение по стилевым предпочтениям для любого интерьера от хай-тек до классики, по форме и цветам.
- Гарантия качества производимой продукции.
- Безопасность продукции.
- Экологичность продукции.

## БАГЕТ ДЕТАЛИ КАЖДОЙ СОВЕРШЕННОСТИ

Багет Decomaster производится из экологически чистого материала – полистирола высокой плотности. Этот современный материал не деформируется со временем, не дает усадки, не впитывает запахи и не боится влажности.

Палитра багетов Decomaster отличается широким разнообразием и может служить неисчерпаемым источником вдохновения. Здесь Вы найдете как благородные классические оттенки серебра, золота, бронзы и дерева, так и современные цветовые решения. Вы сможете подобрать багет различных стилистических направлений: и старинные рамы различных эпох, и рамы в стилях кантри, модерн, техно и других для воплощения любых идей в оформлении пространства.

Большой выбор форм, цветов и размеров позволяет применять багет не только для традиционного оформления картин, зеркал, вышивок и фотографий. Современным трендом является смешение стилей и использование нешаблонных дизайнерских приемов.

Багет Decomaster придаст изысканности и элегантности, позволит добавить тот самый финальный штрих, который сделает Ваш интерьер уникальным.



Отсканируйте QR код  
и ознакомьтесь  
с коллекцией  
багетов на сайте

# DECOMASTER





Длина: 2900 мм

Длина: 2900 мм



947-566

947-954

947-956

947-565

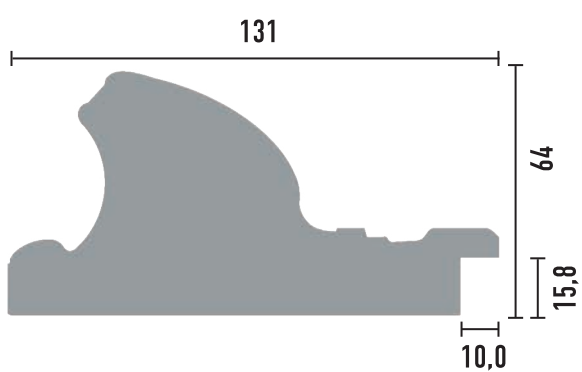

S16-1223

S16-966

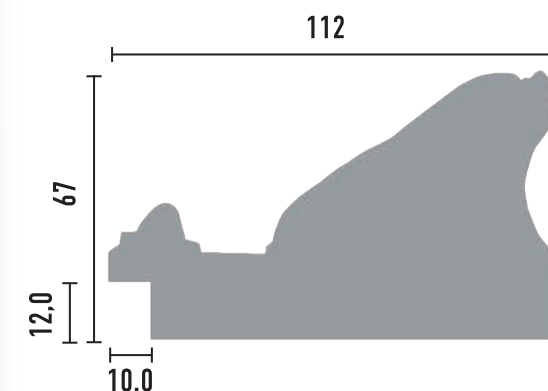



Длина: 2900 мм



230-966



230-1223



230-1543



230-1604B



230-1605B



230-1610



230-70

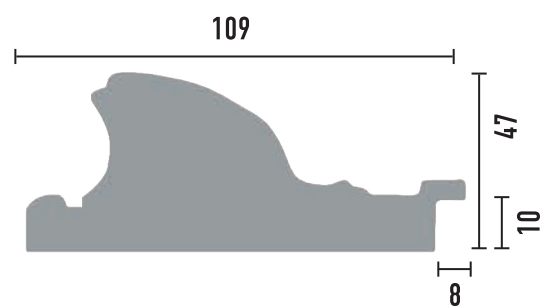

Длина: 2900 мм



980-566

980-565

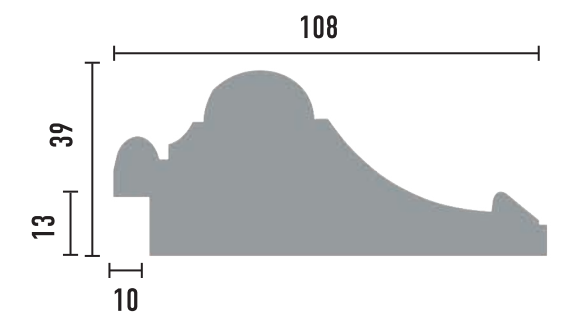



Длина: 2900 мм

Длина: 2900 мм



229-1223



229-966



229-645



229-955

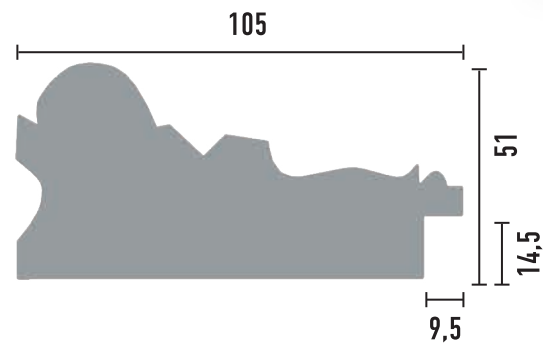

229-1068



229-182

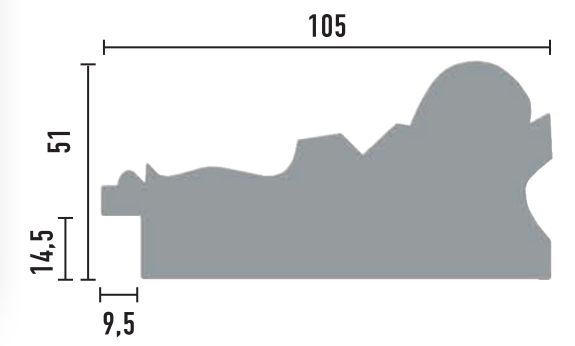





Длина: 2900 мм



400-958

400-954

400-956

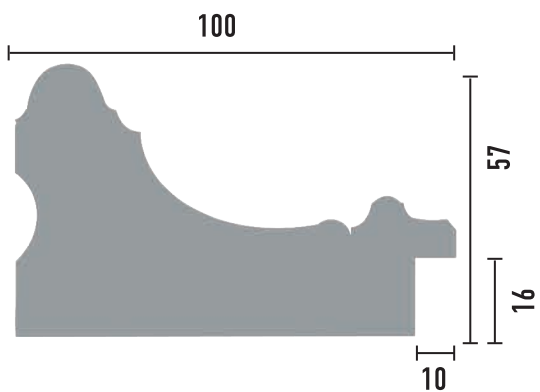

Длина: 2900 мм

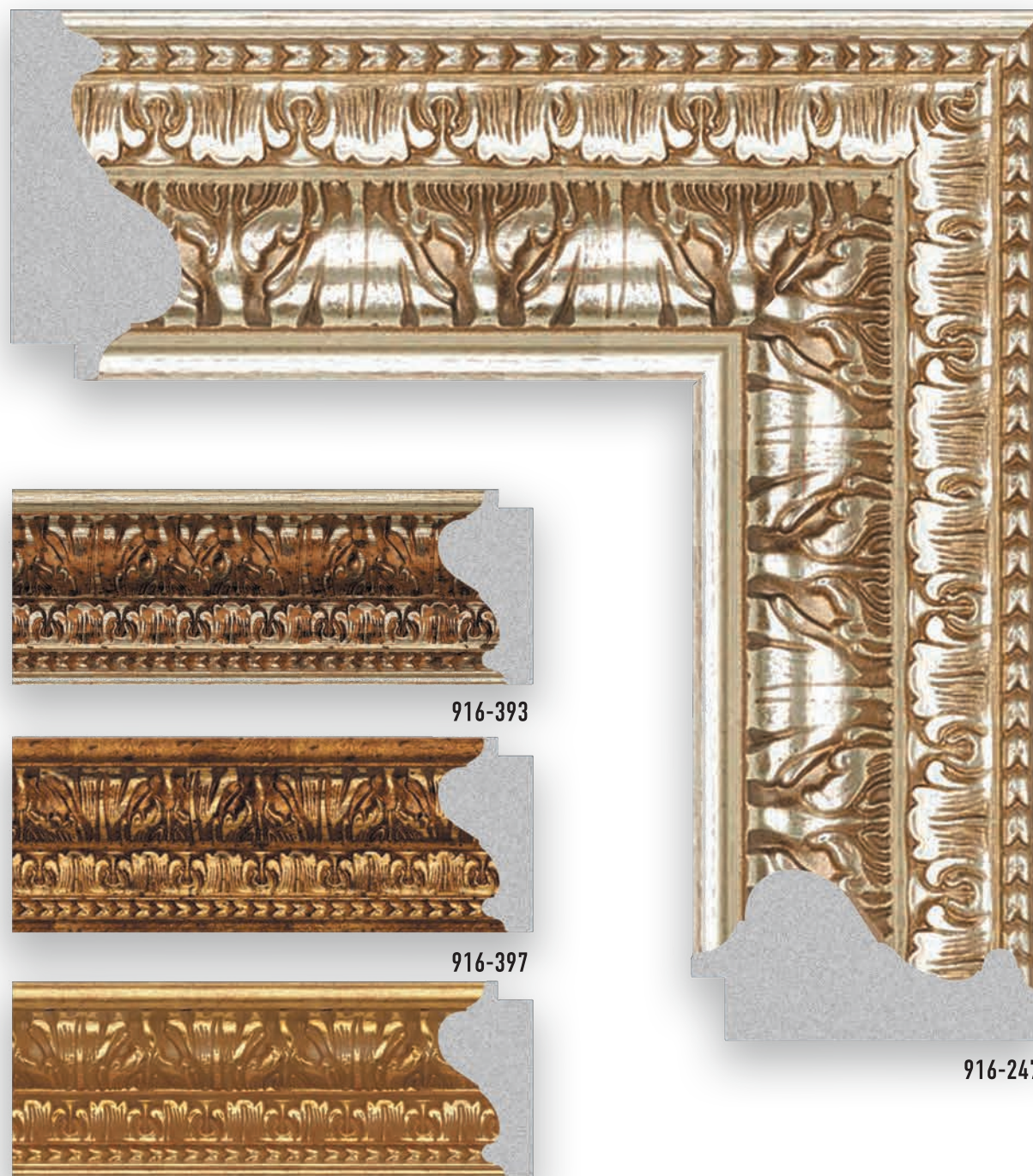

916-393

916-397

916-461

916-247

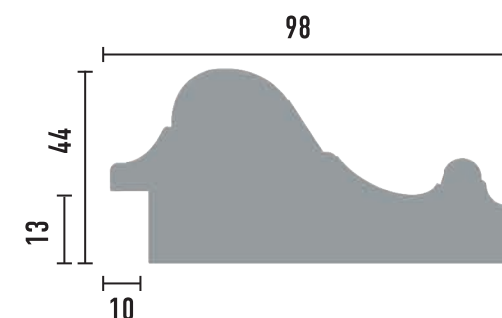



Длина: 2900 мм



214-3



214-373



214-6

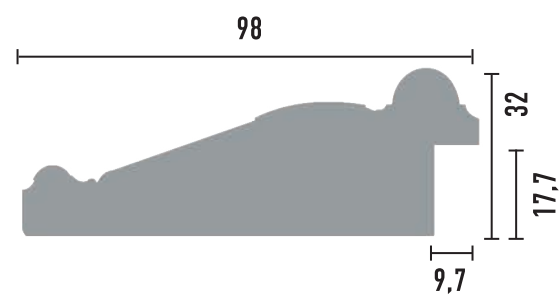

Длина: 2900 мм



S26-1604B



S26-1605B



S26-70

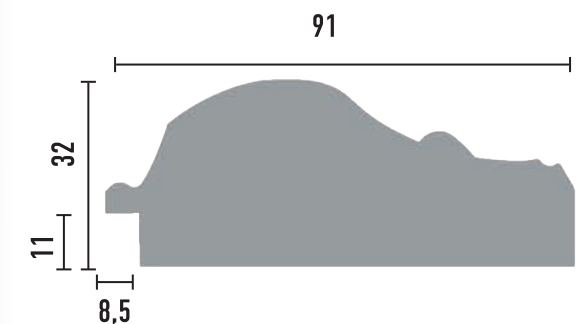



Длина: 2900 мм

Длина: 2900 мм



413-566



413-565



413-919

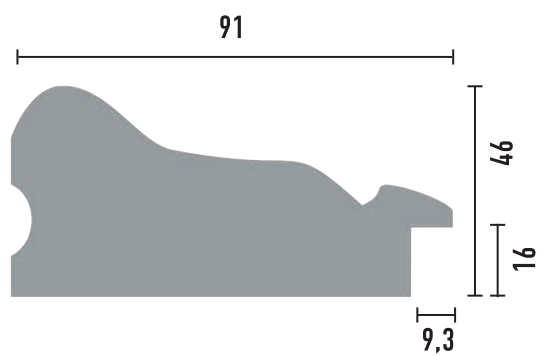

413-494



413-182

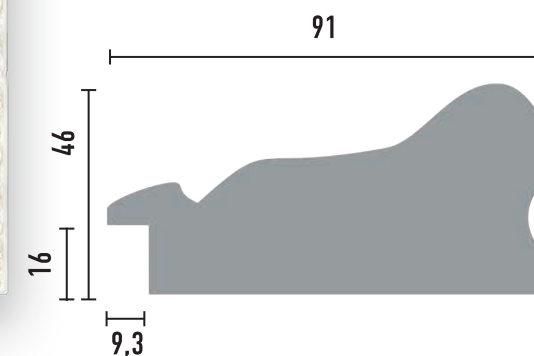



Длина: 2900 мм

Длина: 2900 мм



413-1606



413-1607



413-1608



413-1609

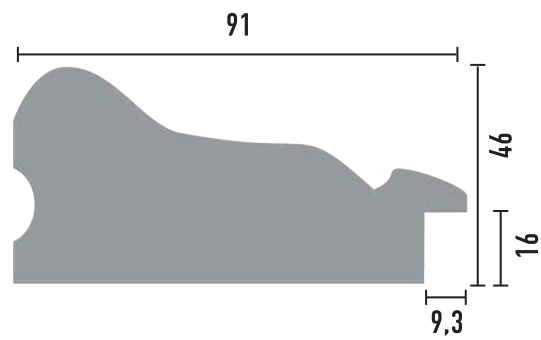

927-252

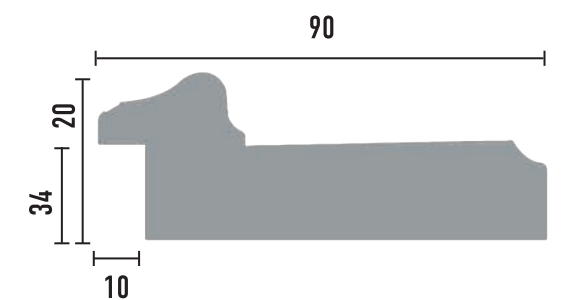



Длина: 2900 мм



293-752

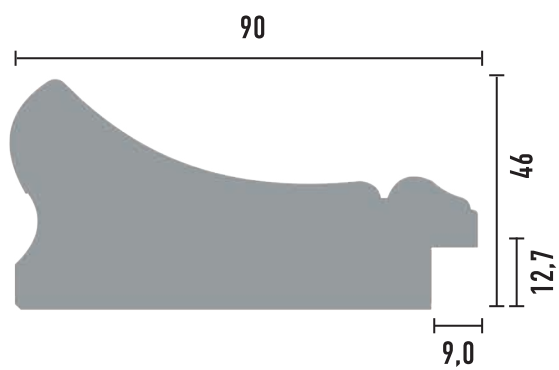

Длина: 2900 мм



849-919

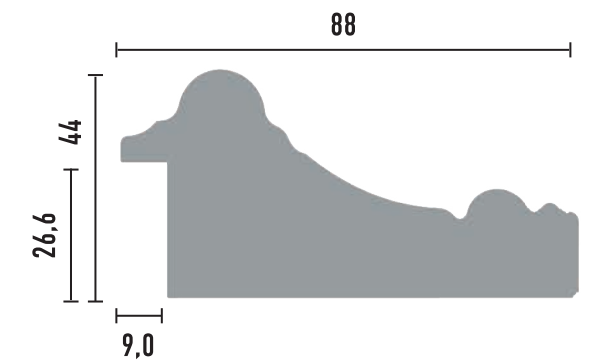



Длина: 2900 мм

Длина: 2900 мм



849-566



849-565



849-373

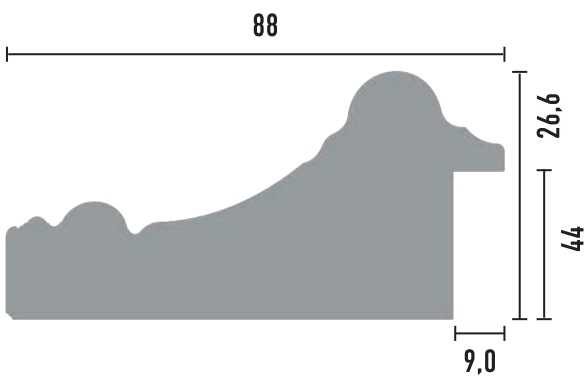

868-645

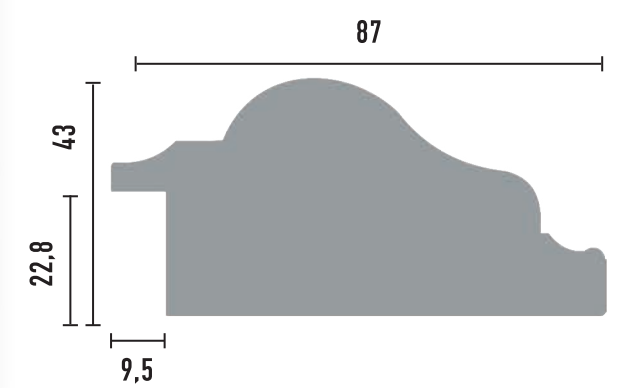





Длина: 2900 мм

Длина: 2900 мм



516-1069



516-1333

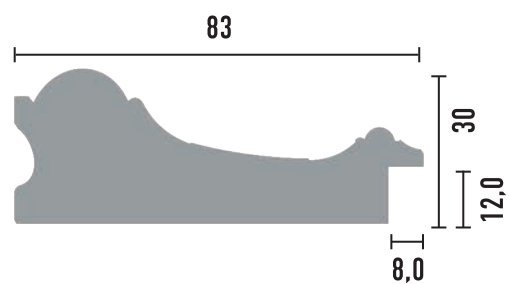

516-767



516-127



516-1070

516-126

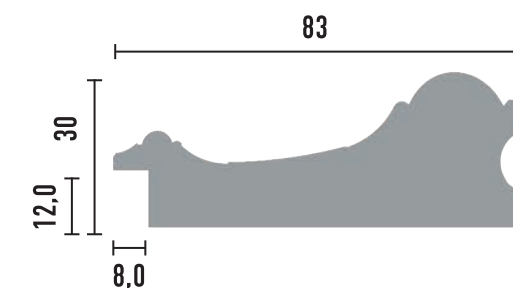



Длина: 2900 мм

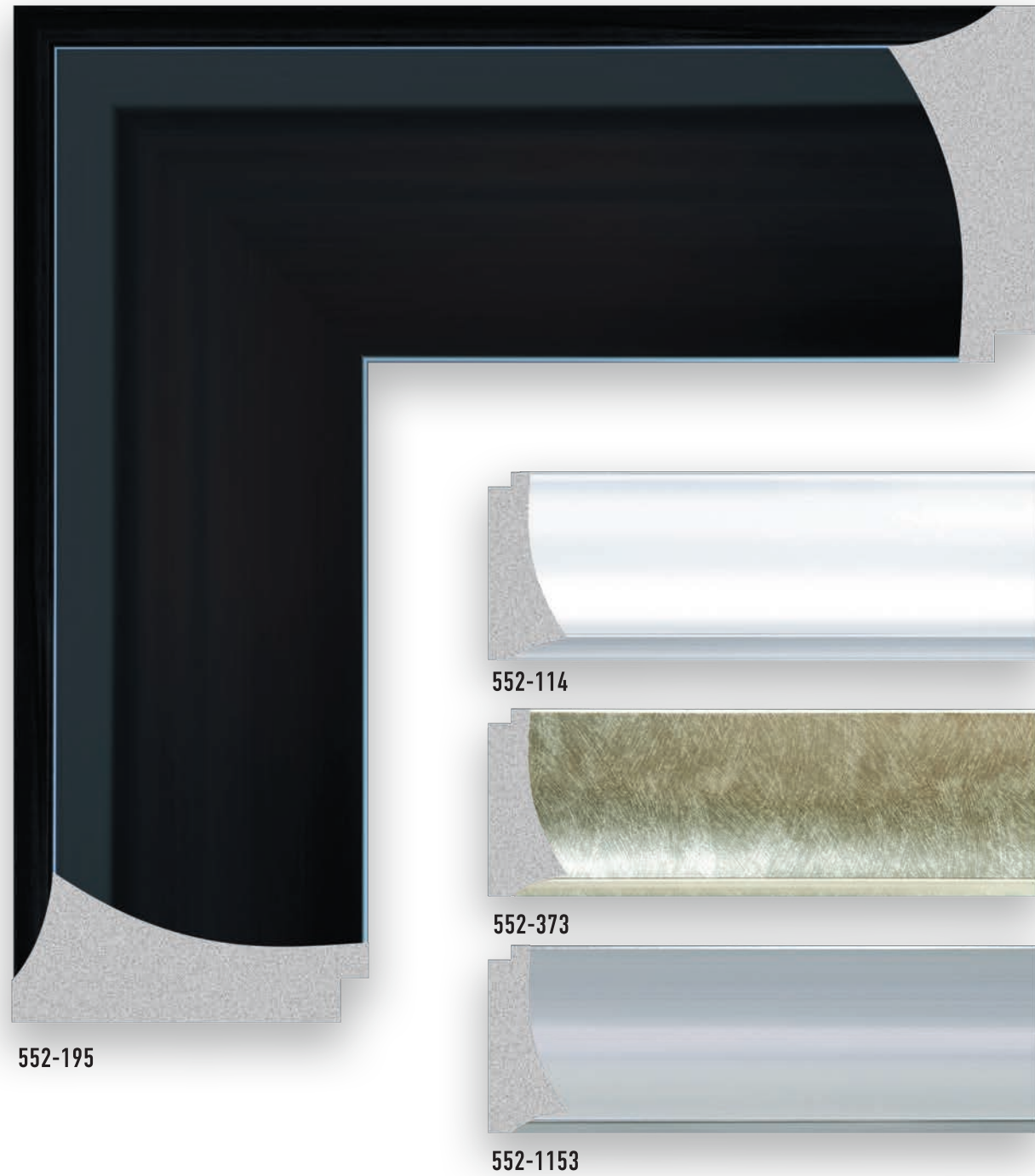

552-195

552-114

552-373

552-1153

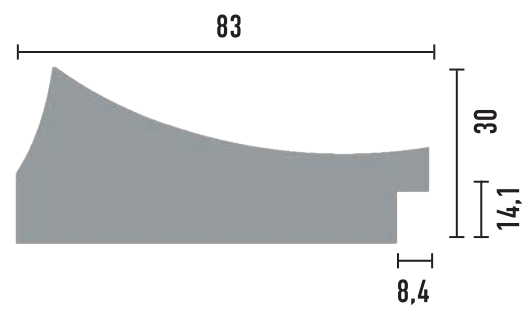

Длина: 2900 мм



552B-1607

552B-1608

552B-1609

552B-1606

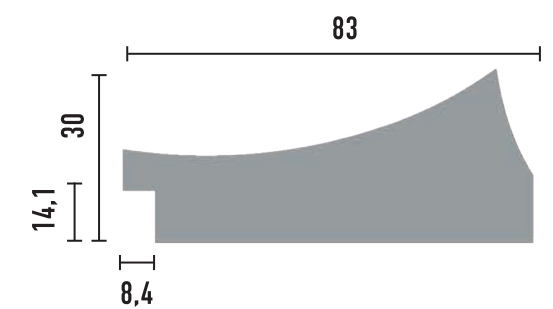



Длина: 2900 мм

Длина: 2900 мм



552C-195

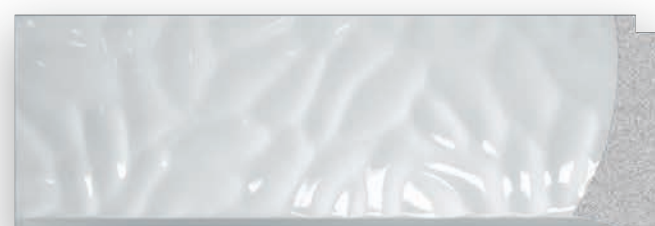

552D-114

552C-114

552D-195

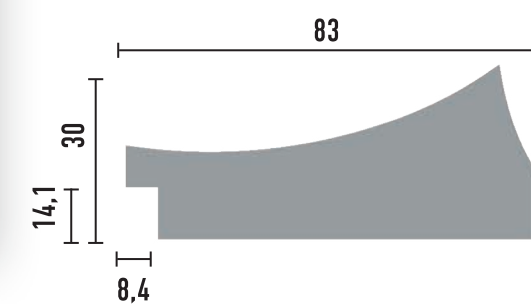
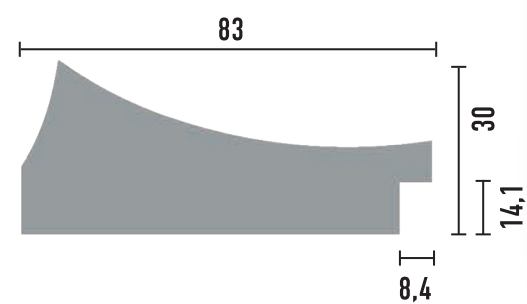





Длина: 2900 мм



S18-966



S18-1223



S18-1224

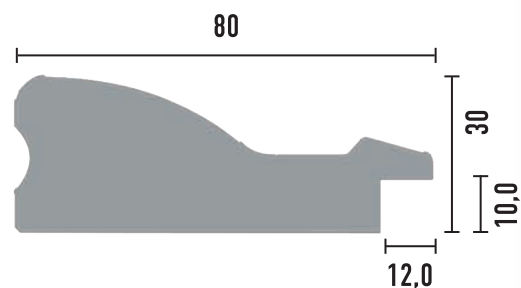

Длина: 2900 мм



696-401



696-182

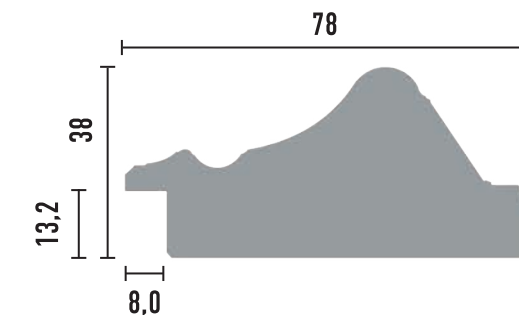



Длина: 2900 мм

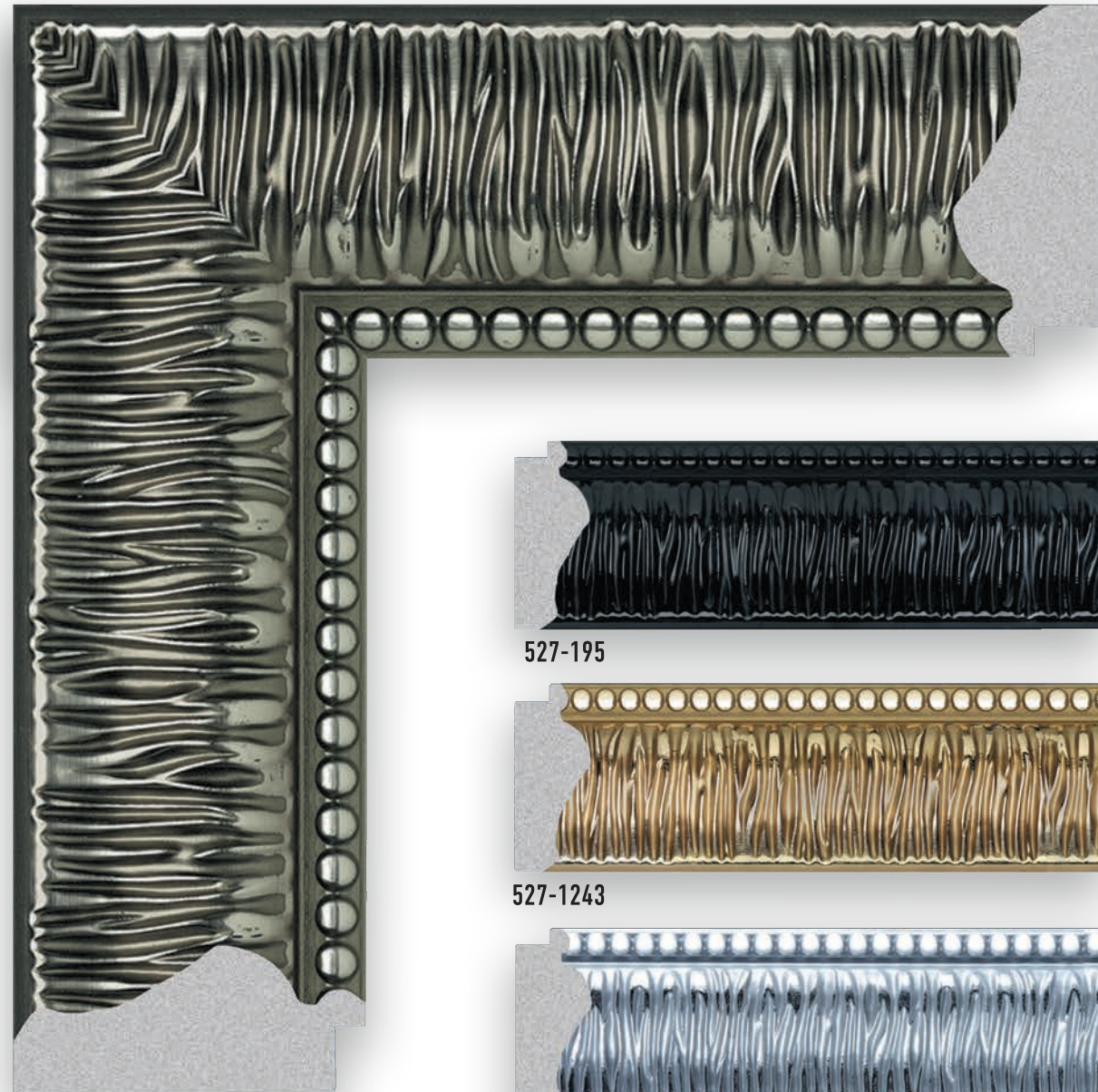

527-725



527-195

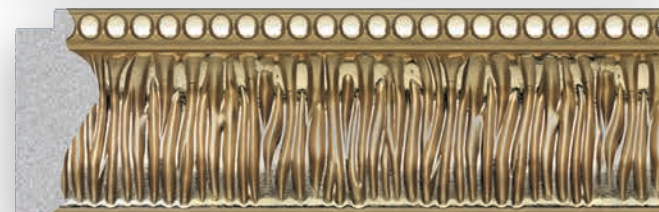

527-1243

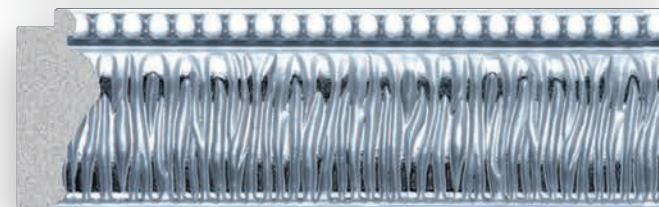

527-1244



527-114

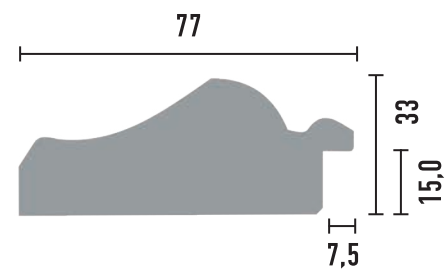

Длина: 2900 мм



919-1604



919-1604B



919-1605



919-1605B

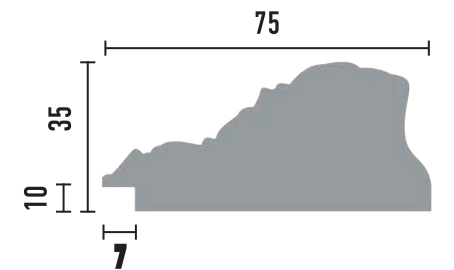

919-70





Длина: 2900 мм



978-565



978-566

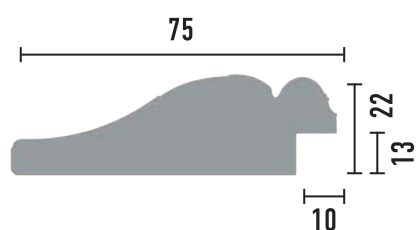

Длина: 2900 мм



582-433



582-438

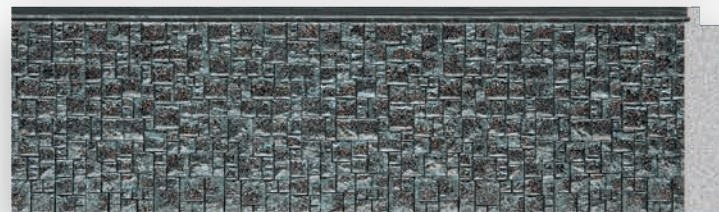

582-27

582-26

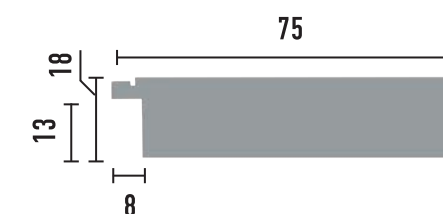



Длина: 2900 мм

Длина: 2400 мм

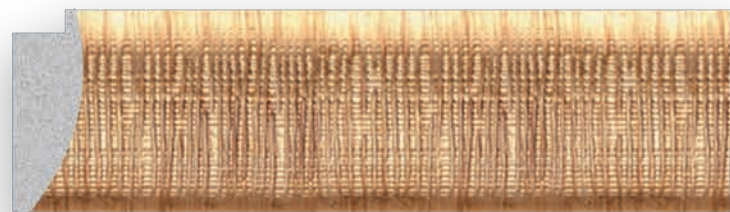

811M-905

811M-906

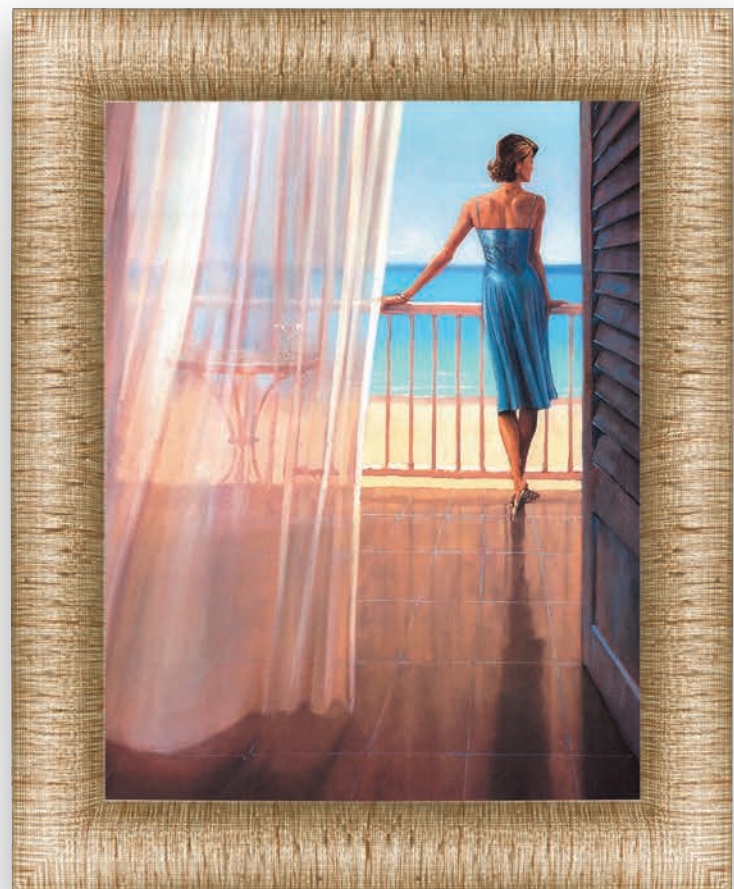
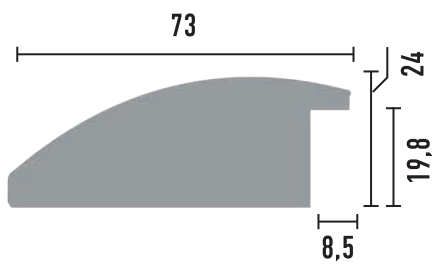

108-1333



108-1069



108-7

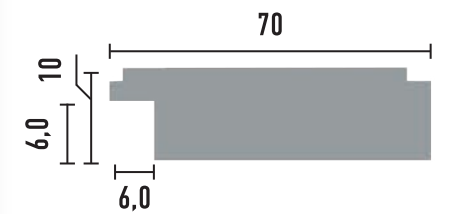





Длина: 2400 мм

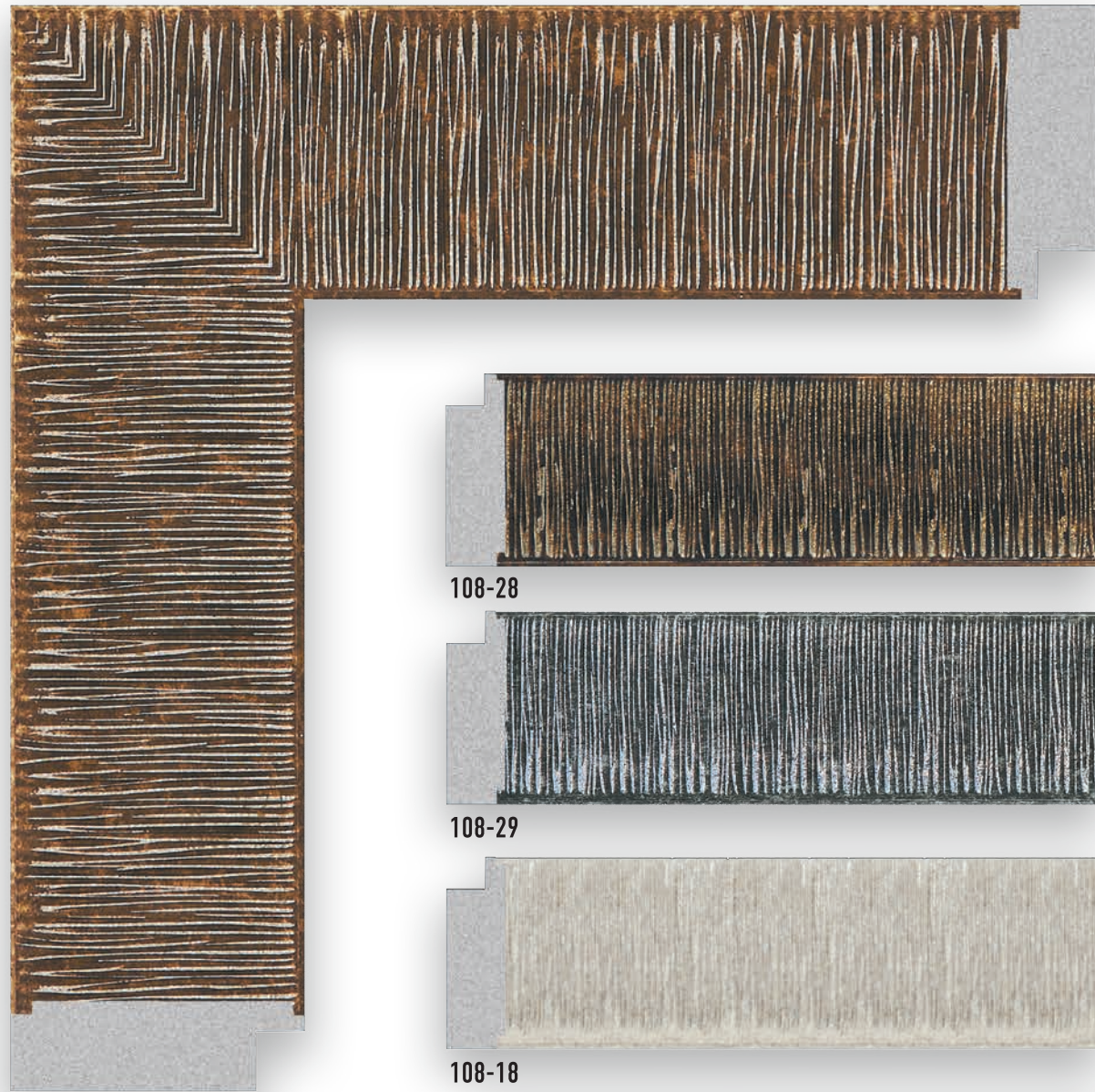

108-17



108-28

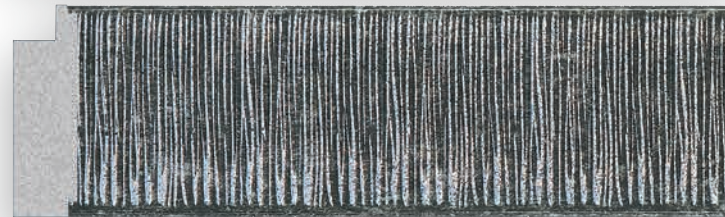

108-29



108-18



108-19



108-20

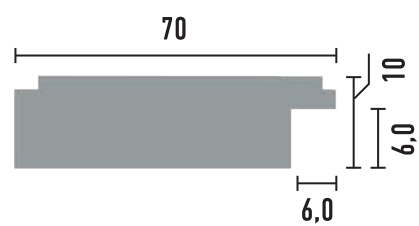

Длина: 2900 мм



577-966



577-1223

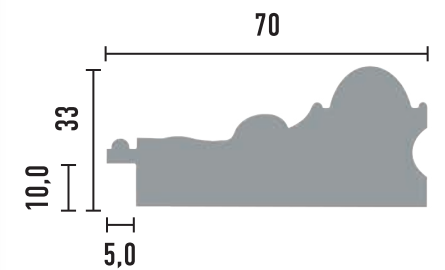



Длина: 2900 мм



566-1223



566-1224



566-1606



566-1607



566-1608



566-1609

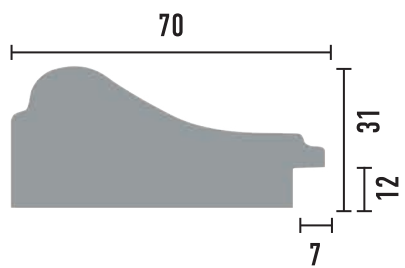

Длина: 2900 мм



690-198



690-182

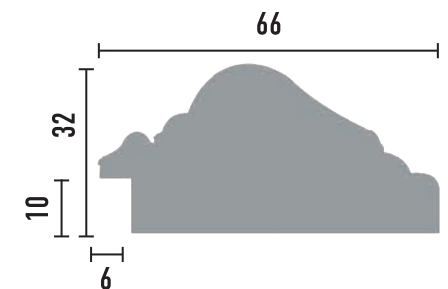





Длина: 2900 мм



524-1070



524-1333



524-1069

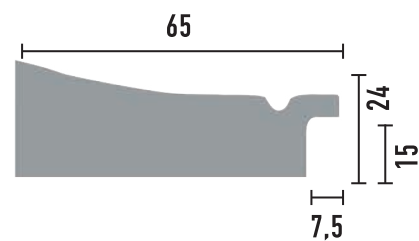

Длина: 2900 мм



176-1



176-3



176-4



176-5



176-6

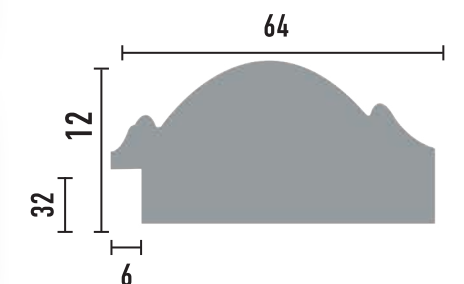





Длина: 2900 мм

Длина: 2900 мм



829-934



829-294



829-935

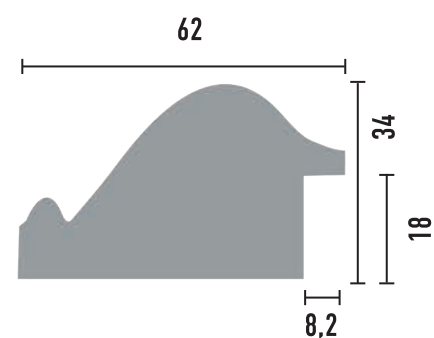

304-126



304-127

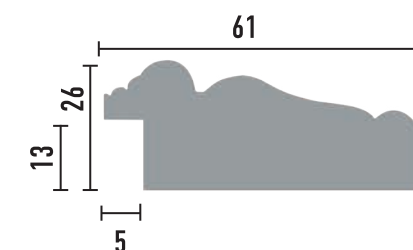





Длина: 2900 мм

Длина: 2900 мм



808-552

808-553

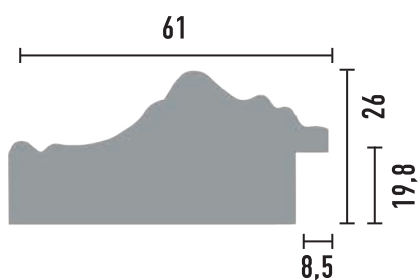

587-1604



587-1604B



587-1605



587-1605B

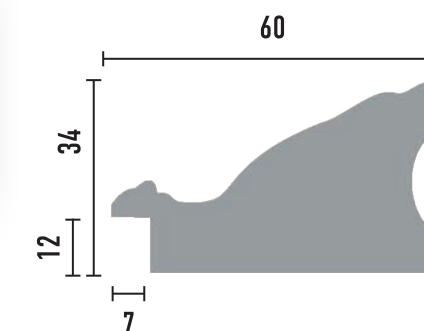

587-70



Длина: 2900 мм

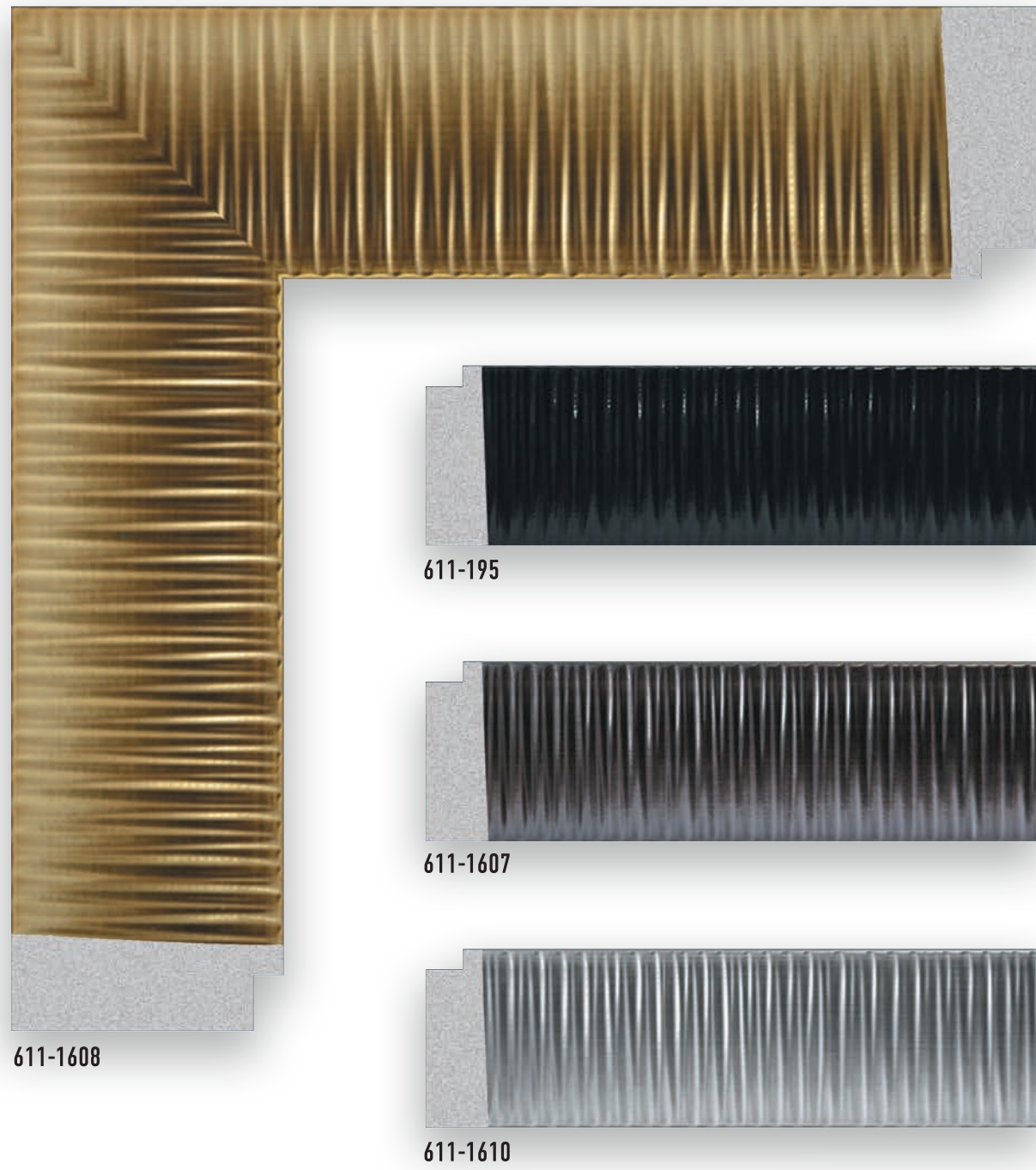

611-1608

611-195

611-1607

611-1610

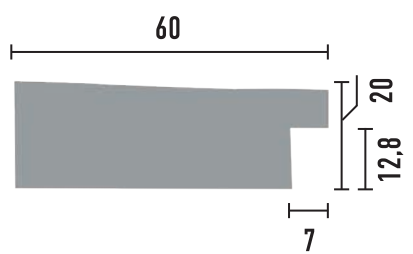

Длина: 2900 мм



175-1

175-2

175-4

175-5

175-6

175-3

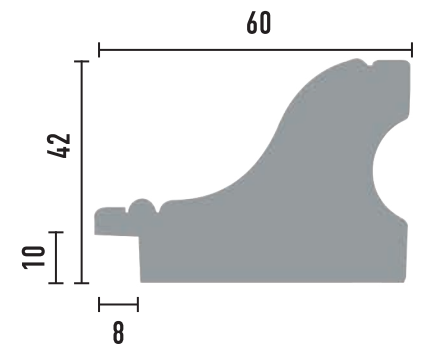



Длина: 2900 мм



548M-440

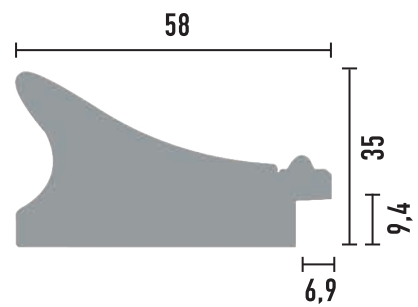

Длина: 2900 мм

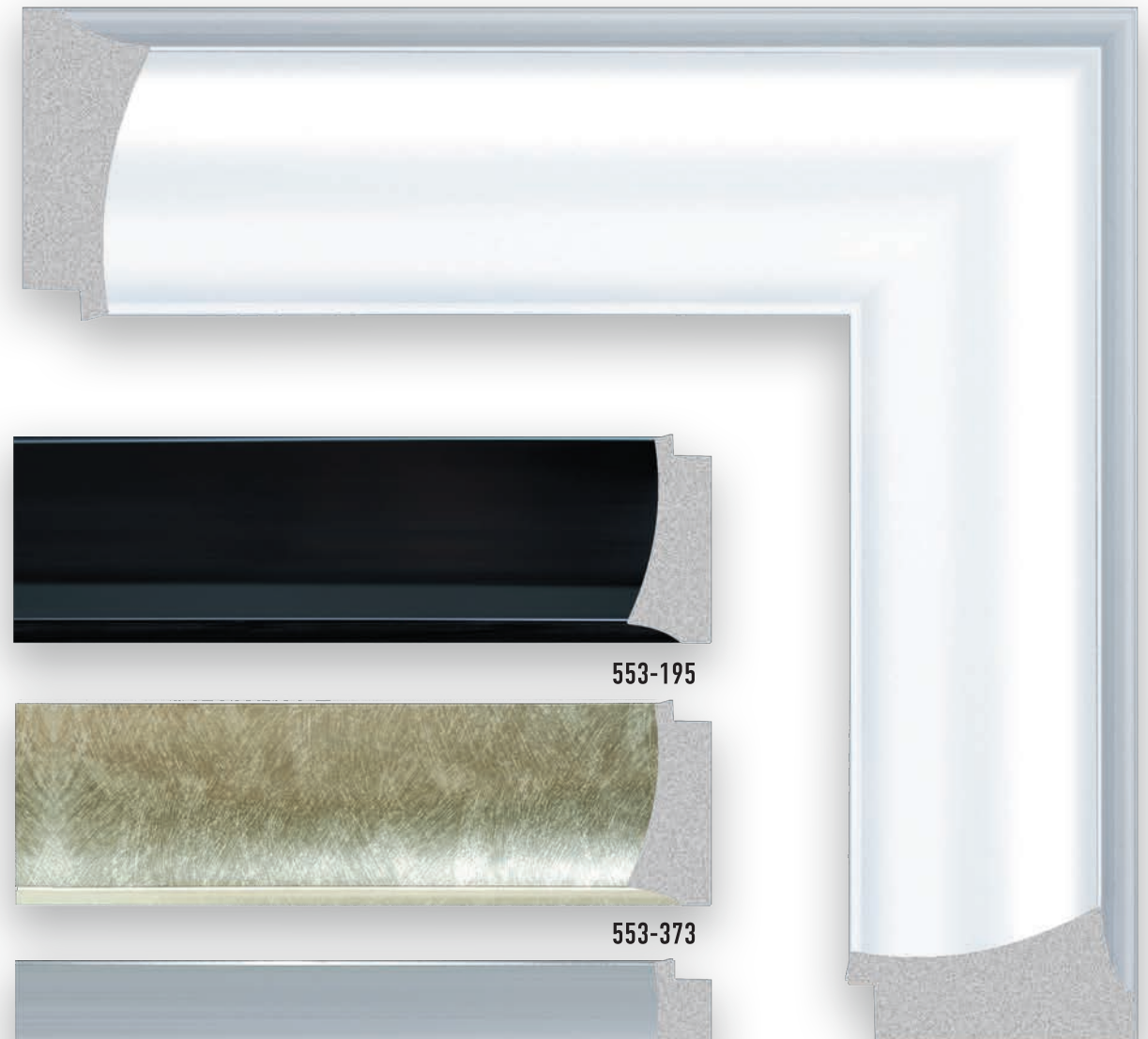

553-195



553-373



553-1153

553-114

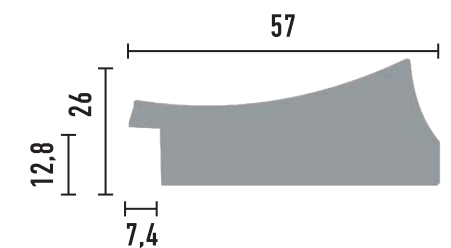





Длина: 2900 мм



556-6



556-2



556-4

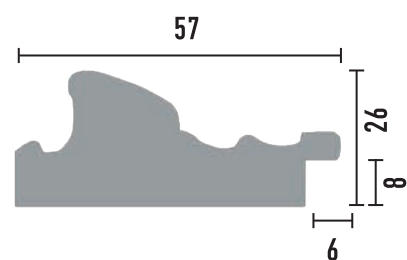

Длина: 2900 мм



J11-1223



J11-115



J11-1224

J11-966

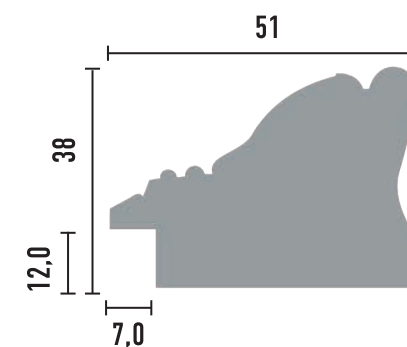





Длина: 2900 мм



686M-565

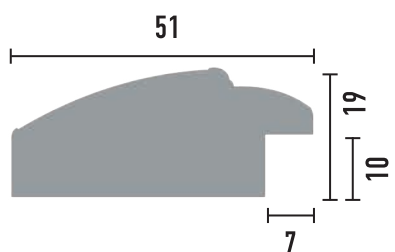

Длина: 2900 мм

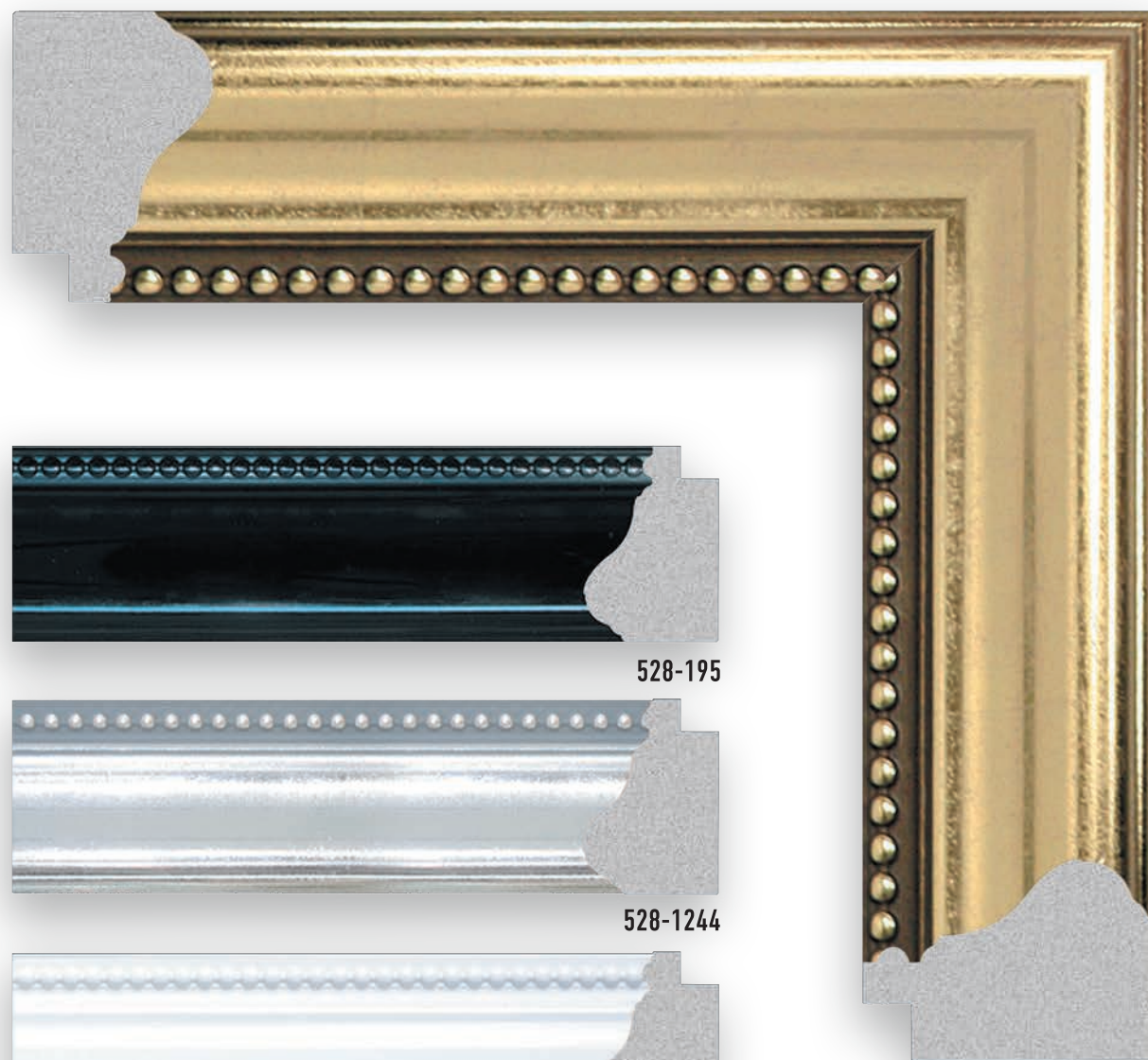

528-195

528-1244

528-114

528-1243

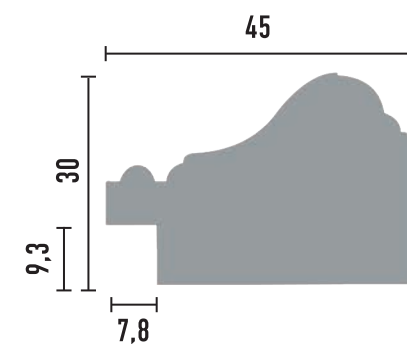





Длина: 2900 мм

Длина: 2900 мм



J13-966



J13-1223



J13-1224

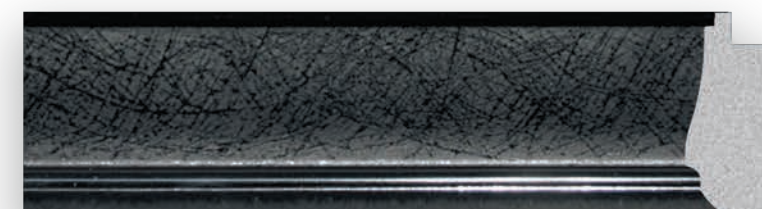
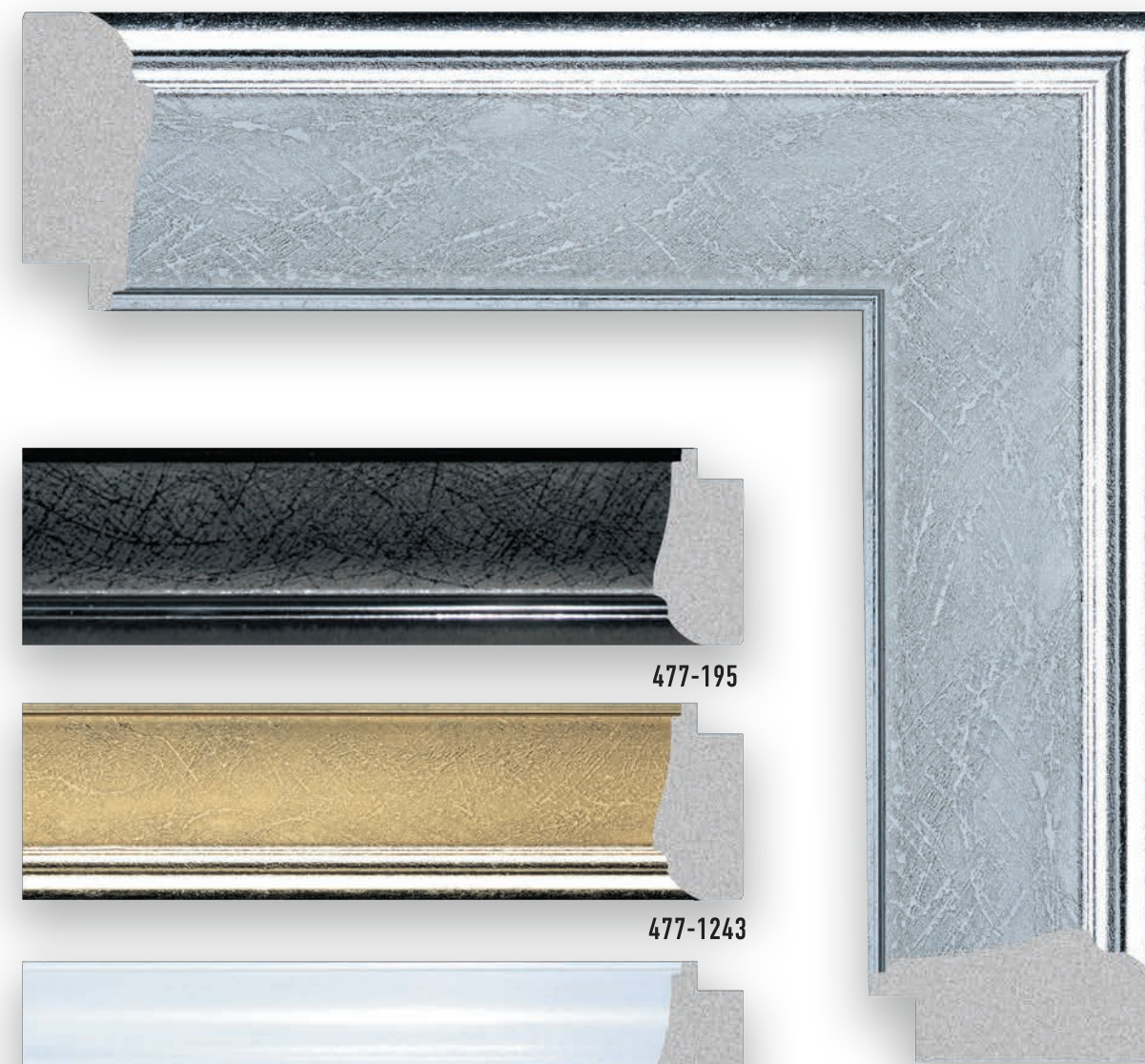
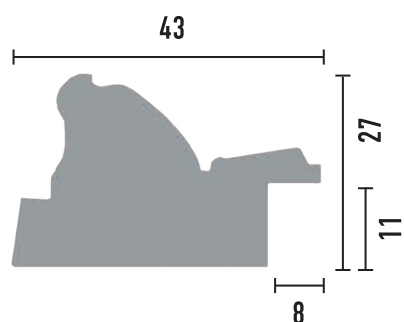

477-195



477-1243



477-114

477-1244

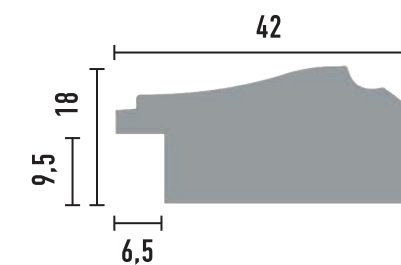



Длина: 2900 мм



807-2

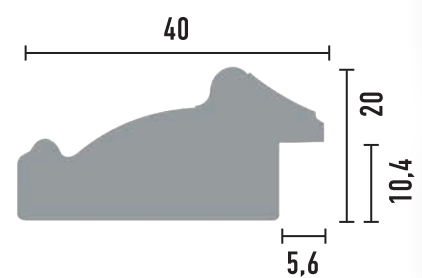

807-1



807-3



807-4



807-5

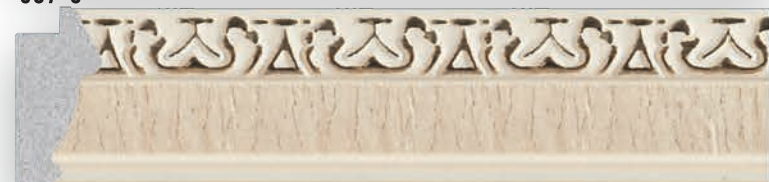

807-6



807-7D

Длина: 2900 мм



807-56

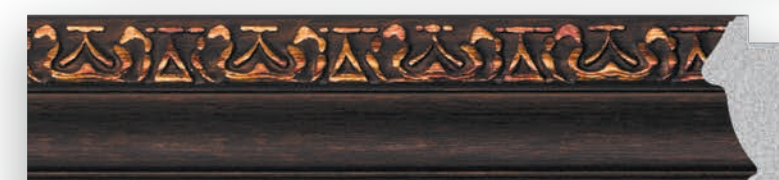

807-966



807-57



807-1223



807-58

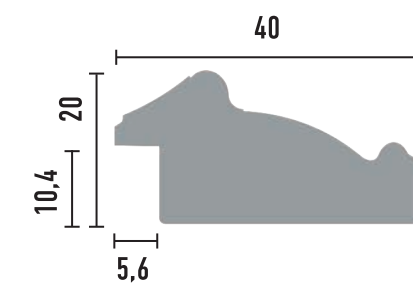



Длина: 2900 мм



807-552



807-553



807-43



807-44



807-41



807-40



807-42

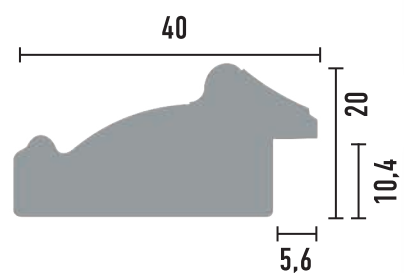

Длина: 2900 мм



807-59



807-18D



807-19D



807-60



807-63

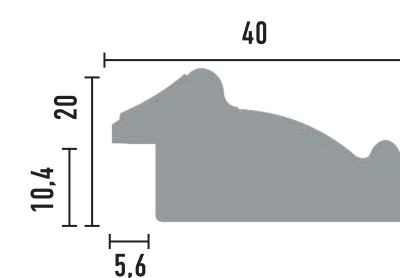





Длина: 2900 мм



109-11

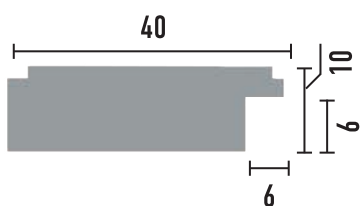

Длина: 2400 мм



109-17

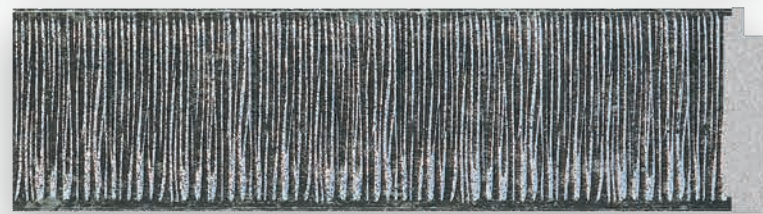

109-29



109-18



109-19



109-20

109-28

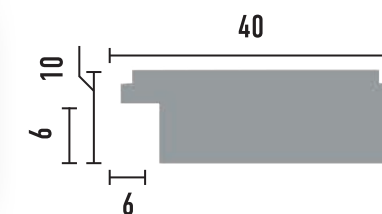



Длина: 2900 мм



685-221



685-126



685-127



685-182

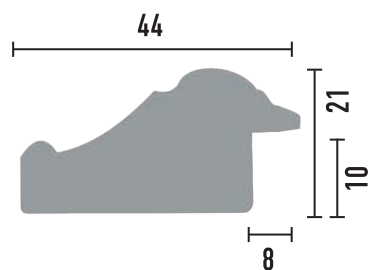

Длина: 2900 мм



J12-1224

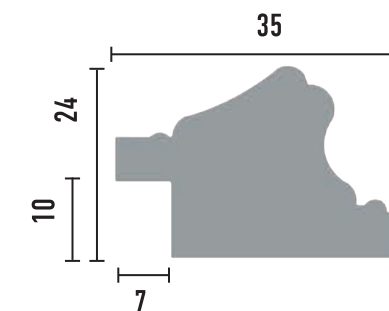



Длина: 2900 мм



534-15



534-51



534-52



534-53



534-11



534-13



534-14

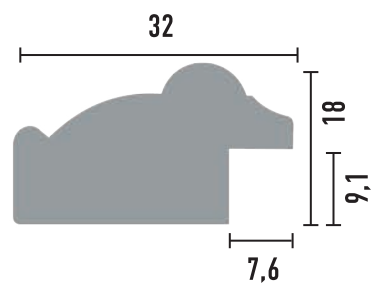

Длина: 2900 мм



651-176s



651-176

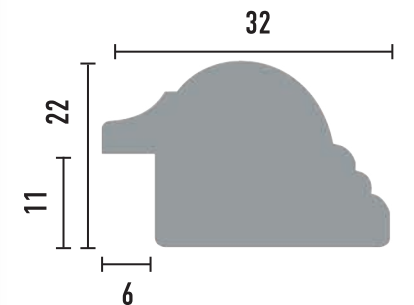



Длина: 2900 мм

Длина: 2900 мм



564-277

564-280

564-278

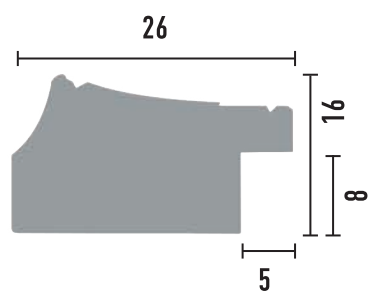

584-1070

584-1333

584-1069

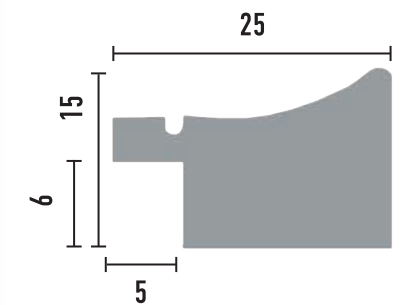





Длина: 2900 мм

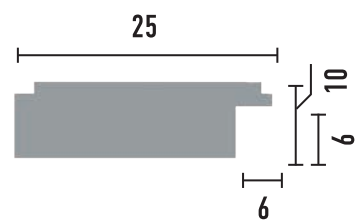

Длина: 2400 мм

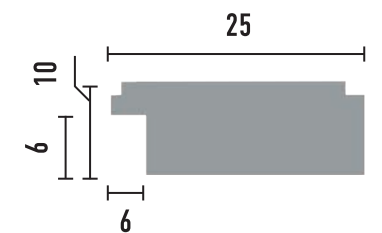





Длина: 2900 мм

Длина: 2400 мм

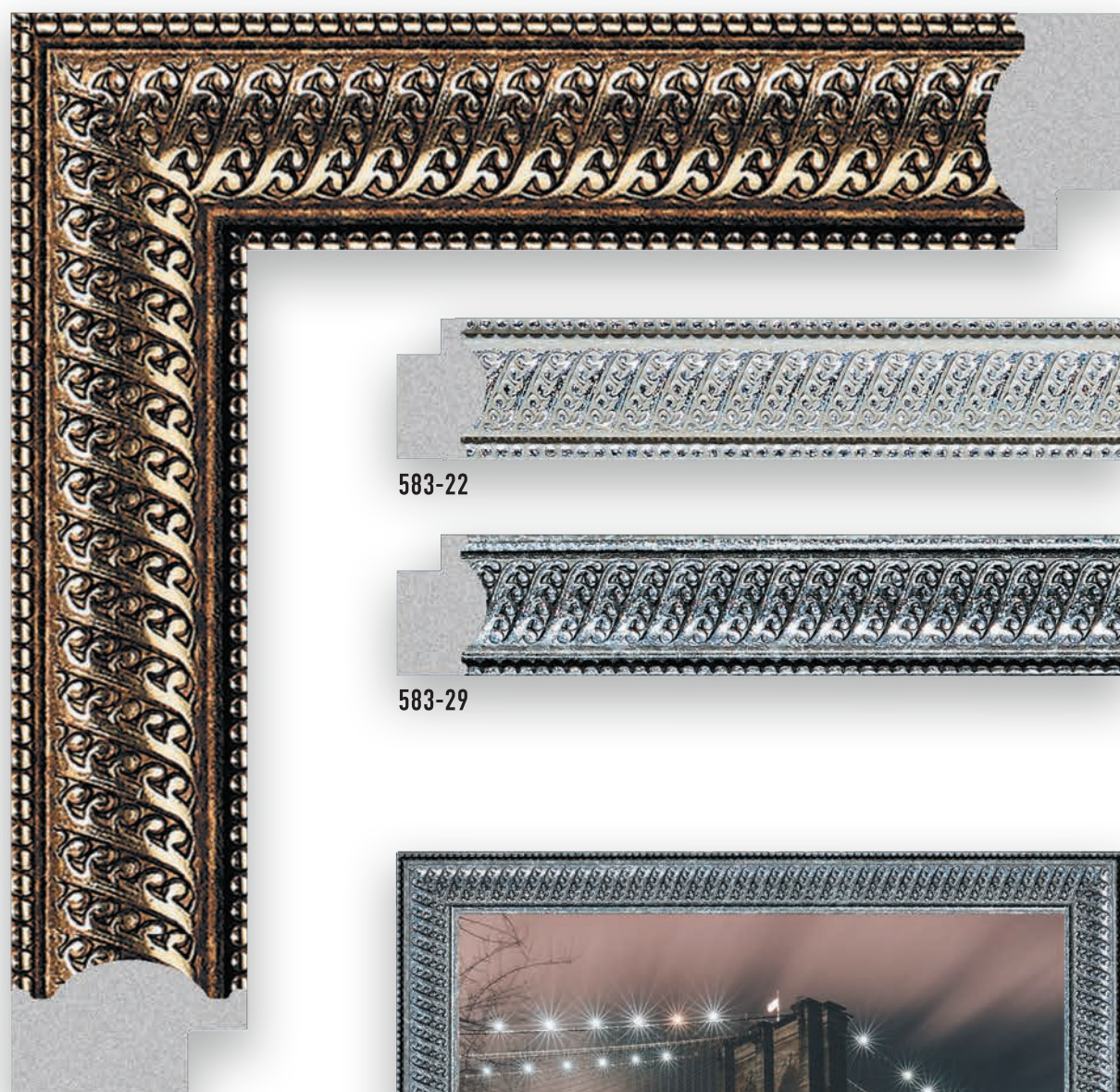

583-22



583-29

583-28

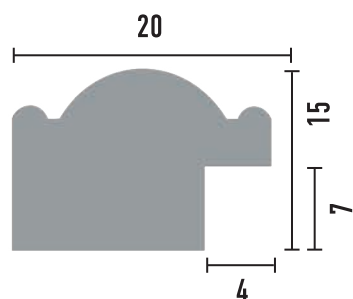

158-3



158-4



158-5



158-6



158-7D



158-937



158-933



158-55

158-1

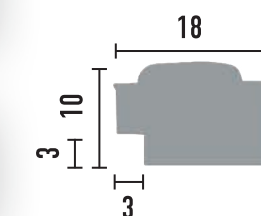





Длина: 2900 мм



158-552



158-767

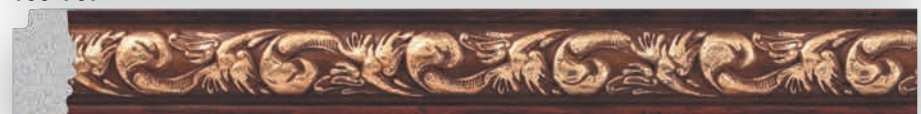

158-1084



158-553



158-54



158-115

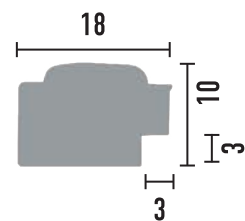

Длина: 2400 мм



158-281



158-118



158-127



158-126



158-1028

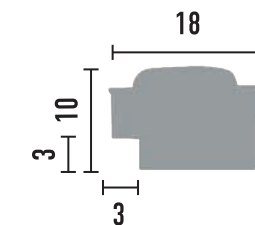



Длина: 2400 мм

Длина: 2900 мм

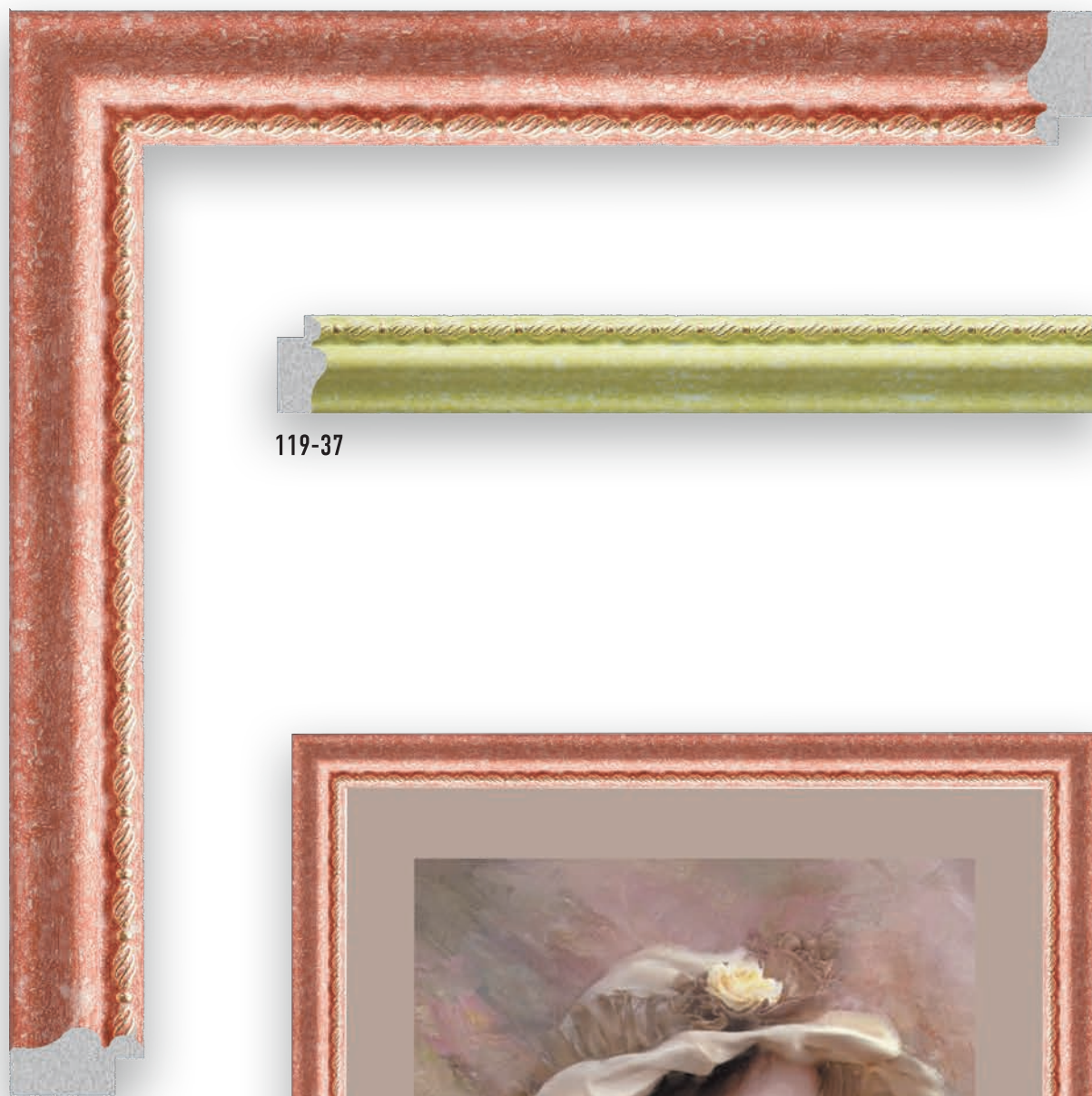

119-37

119-34

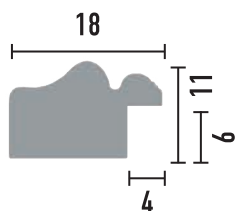

149-956

149-954

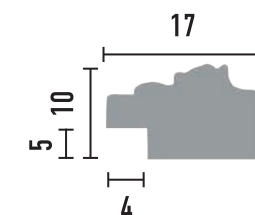



Длина: 2400 мм



117-438

117-553

117-552

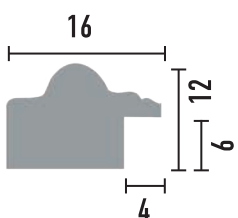

Длина: 2400 мм



159B-565

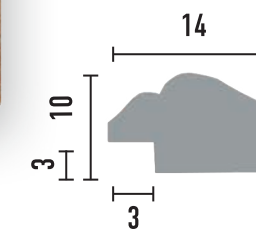



Длина: 2400 мм



159D-552

Длина: 2400 мм



118-29

118-17

118-19

118-20

118-18





Длина: 2850 мм



FM22-2

FM22-1

FM22-3

FM22-4

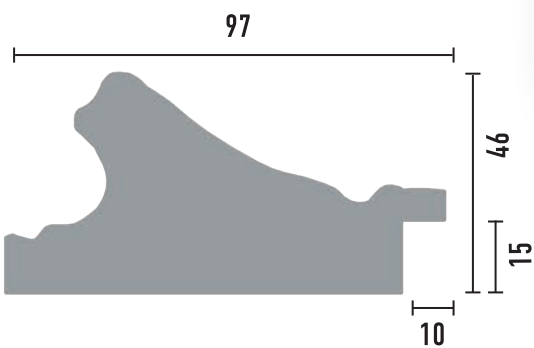

Длина: 2850 мм



FM9-1

FM9-3

FM9-4

FM9-5

FM9-2

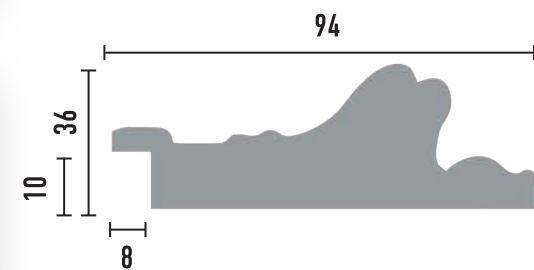





Длина: 2850 мм



FM28-2



FM28-1

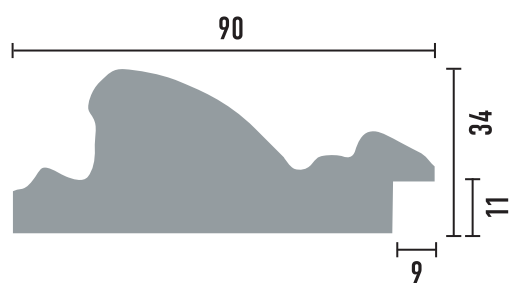

Длина: 2850 мм



FM26-1



FM26-2

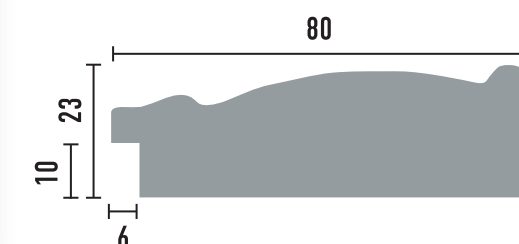



Длина: 2850 мм

Длина: 2850 мм



FM8-1

FM8-2

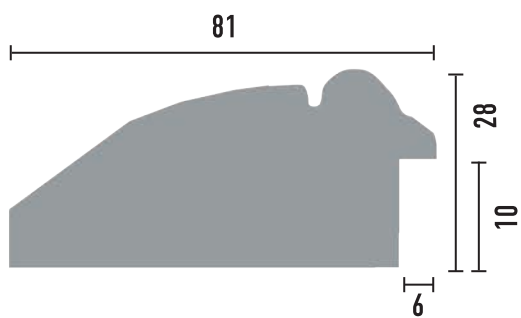

FM4-3

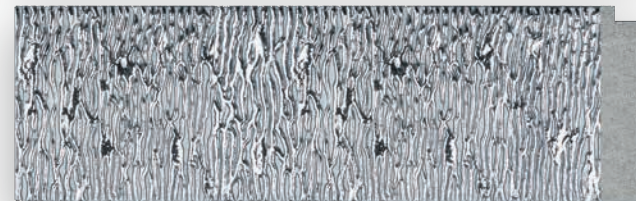

FM4-1

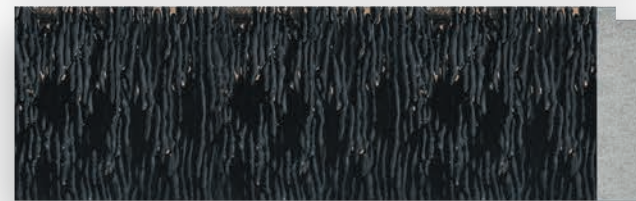

FM4-4



FM4-2

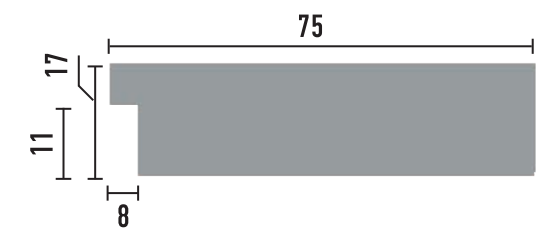





Длина: 2850 мм

Длина: 2850 мм



FM29-2

FM29-1

FM29-3

FM29-4

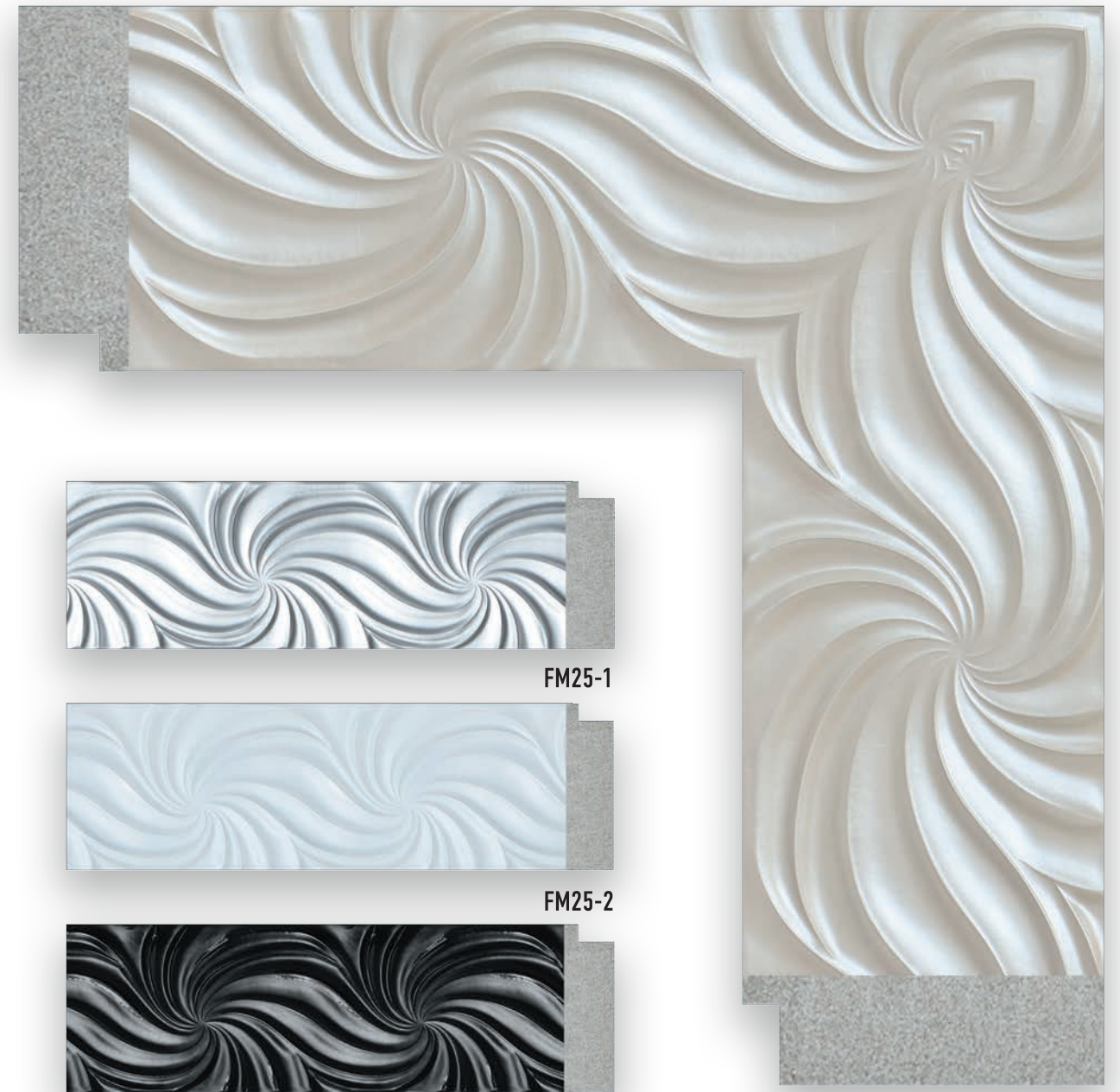

FM25-1

FM25-2

FM25-3

FM25-4

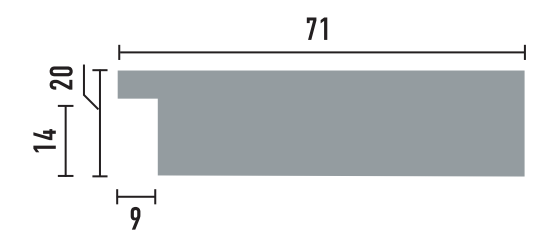
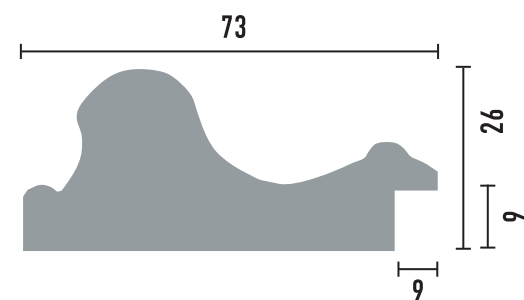





Длина: 2850 мм



FM24-1

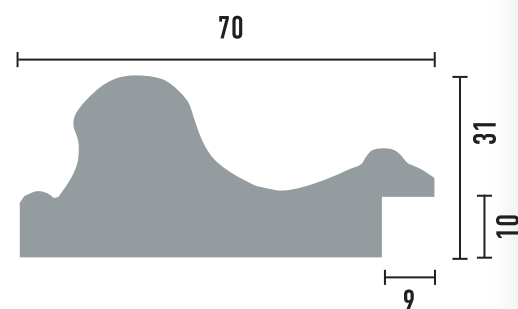

Длина: 2850 мм



FM11-2

FM11-1

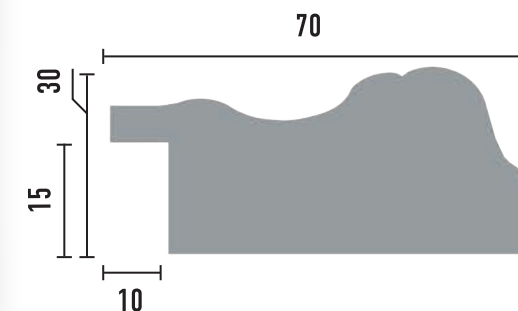





Длина: 2850 мм

Длина: 2850 мм



FM14-1

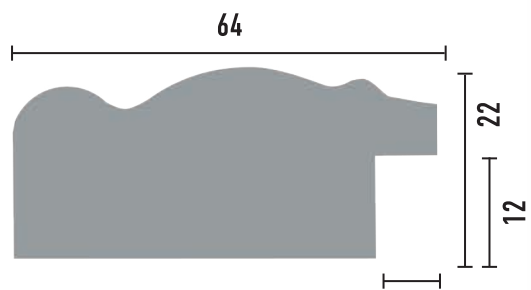

FM21-1

FM21-2

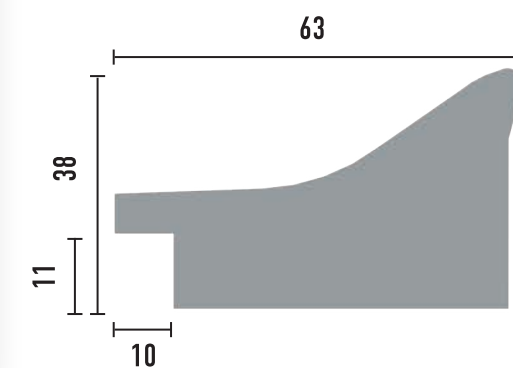





Длина: 2850 мм



FM10-3

FM10-2

FM10-1

FM10-4

FM10-5

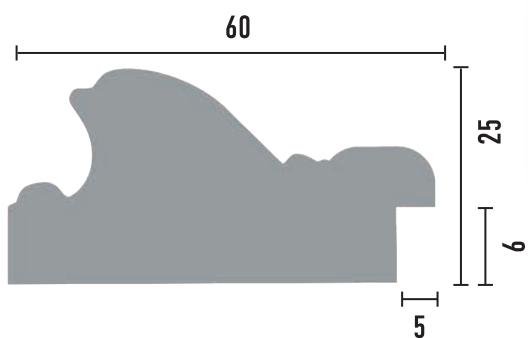

Длина: 2850 мм



FM31-1

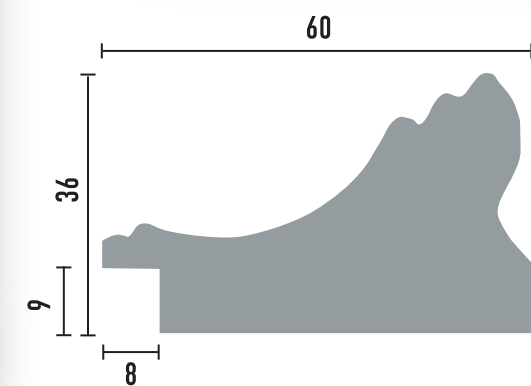



Длина: 2850 мм

Длина: 2850 мм



FM19-2



FM19-1

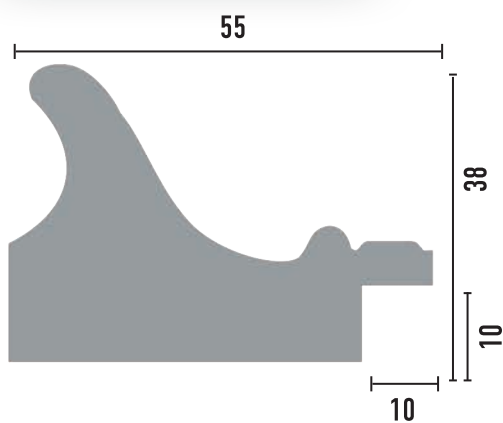

FM21-1

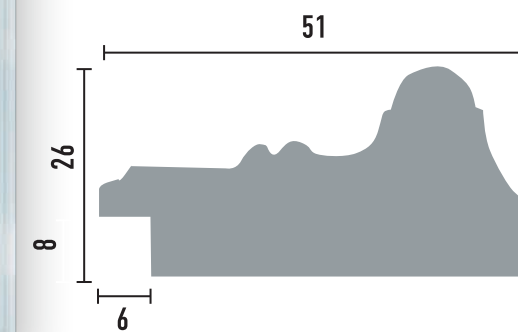





Длина: 2850 мм

Длина: 2850 мм

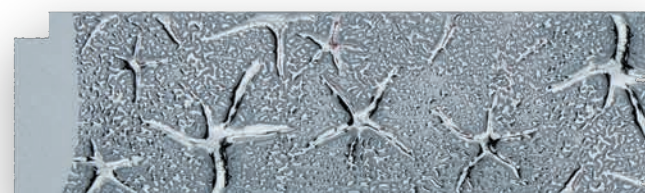
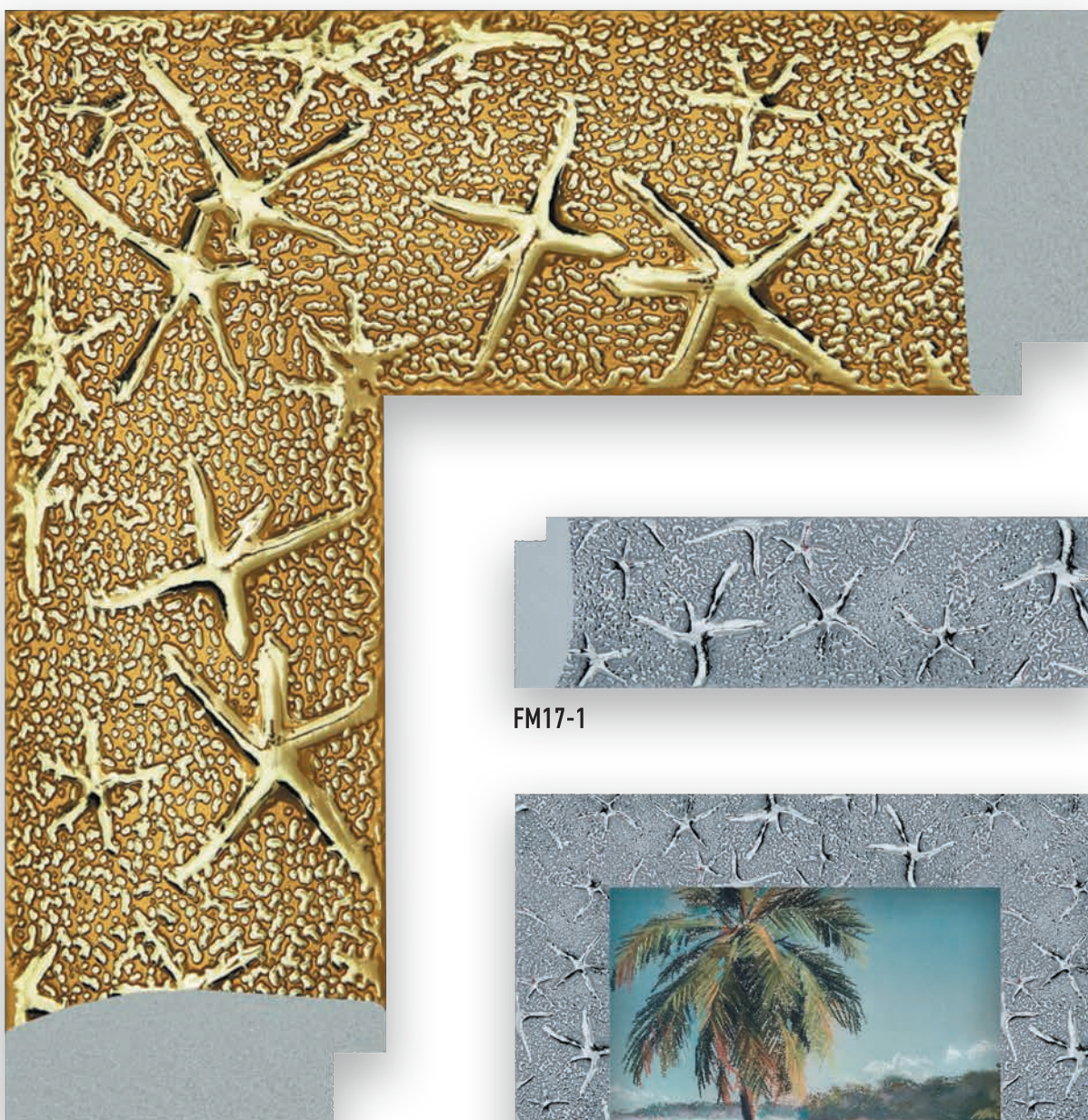

FM17-1

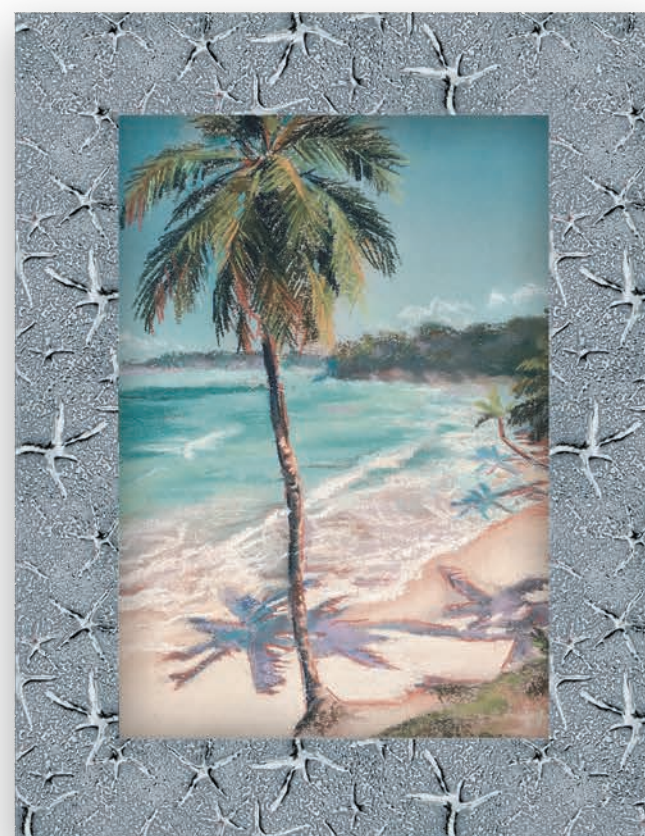

FM17-2

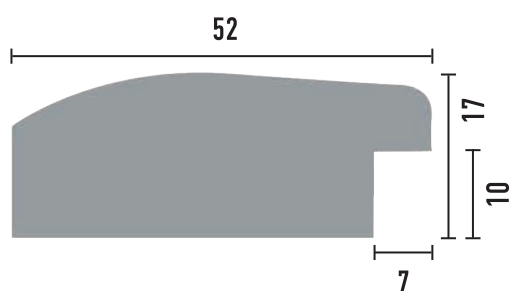

FM15-2



FM15-1

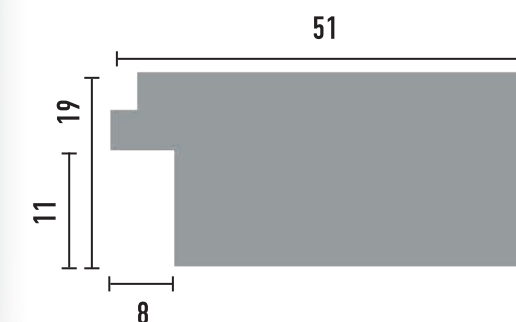





Длина: 2850 мм



FM30-2

FM30-1

FM30-3

FM30-4

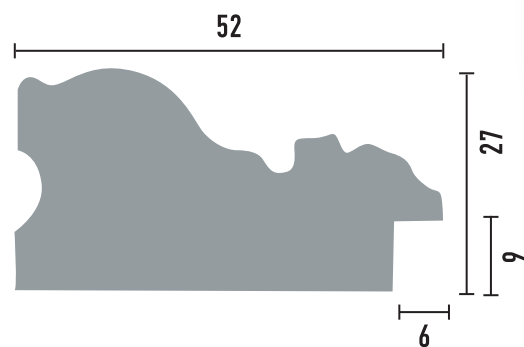

Длина: 2850 мм



FM23-1

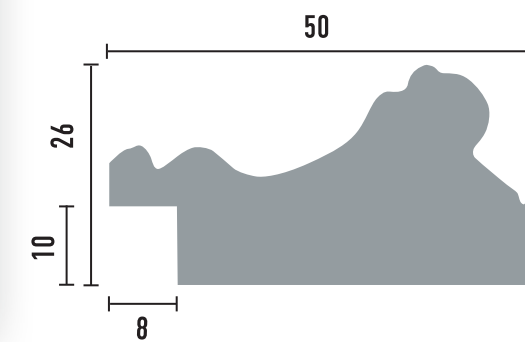



Длина: 2850 мм

Длина: 2850 мм



FM12-1

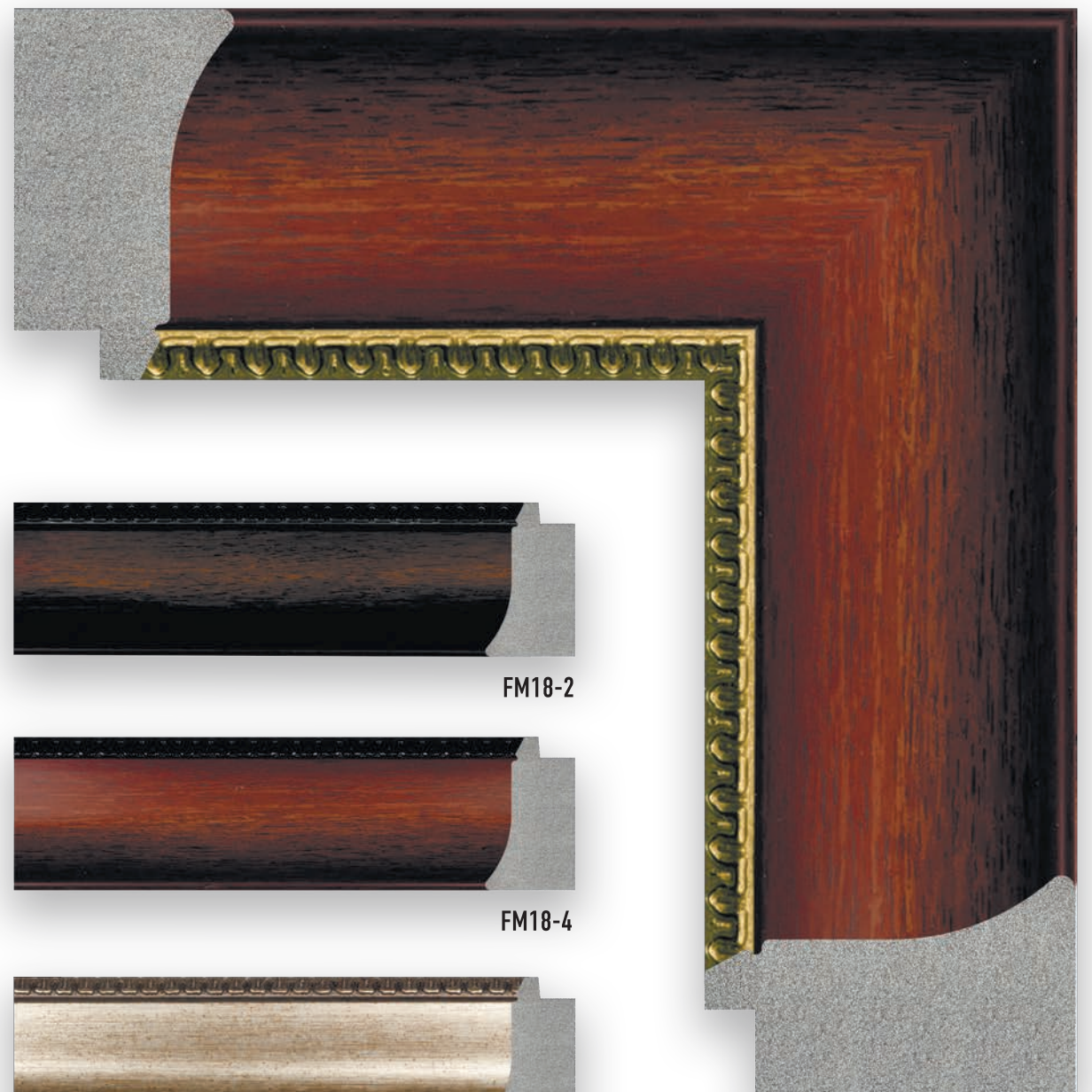

FM18-2



FM18-4



FM18-1

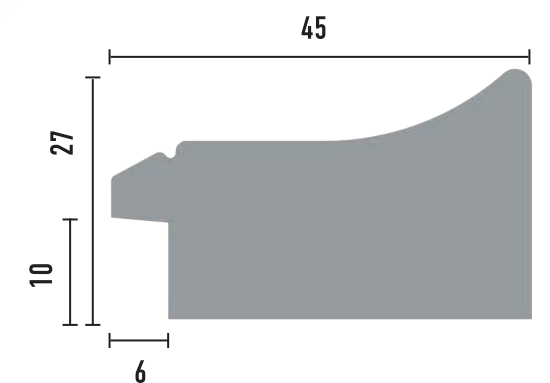
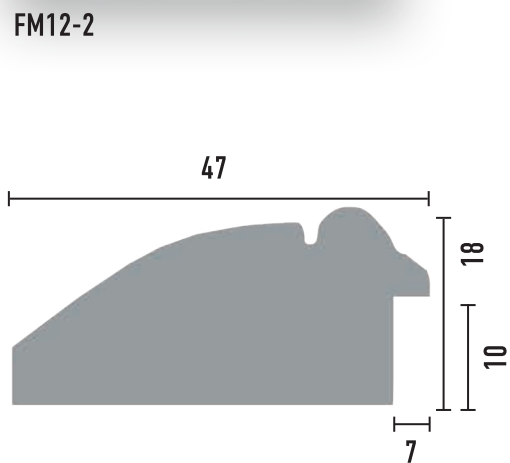

FM18-3



Длина: 2850 мм

Длина: 2850 мм

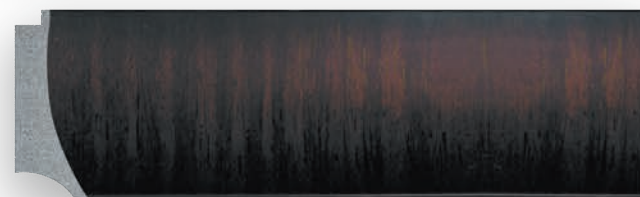
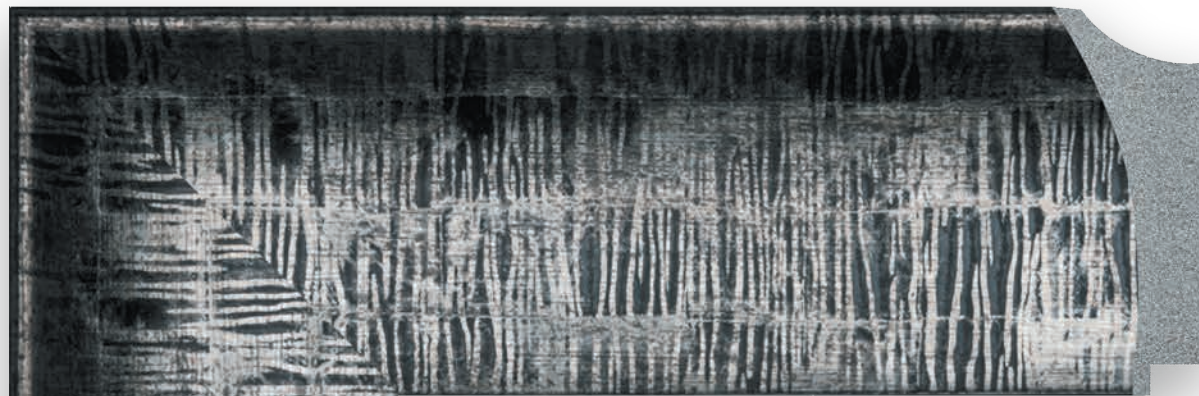

FM5-1



FM5-2



FM5-4

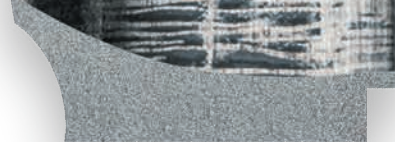

FM5-3

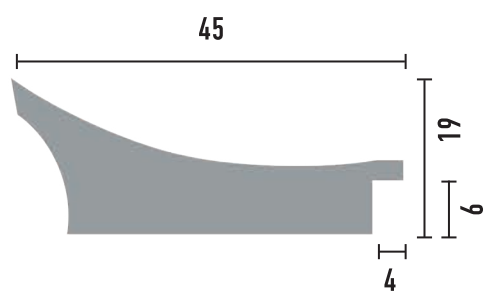

FM6-2



FM6-1

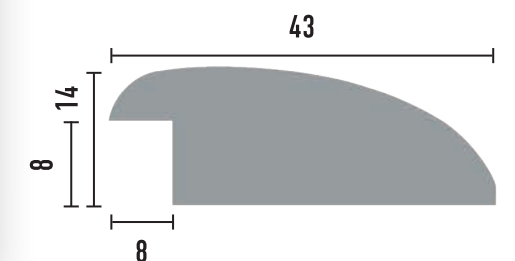



Длина: 2850 мм

Длина: 2850 мм



FM20-1

FM20-2

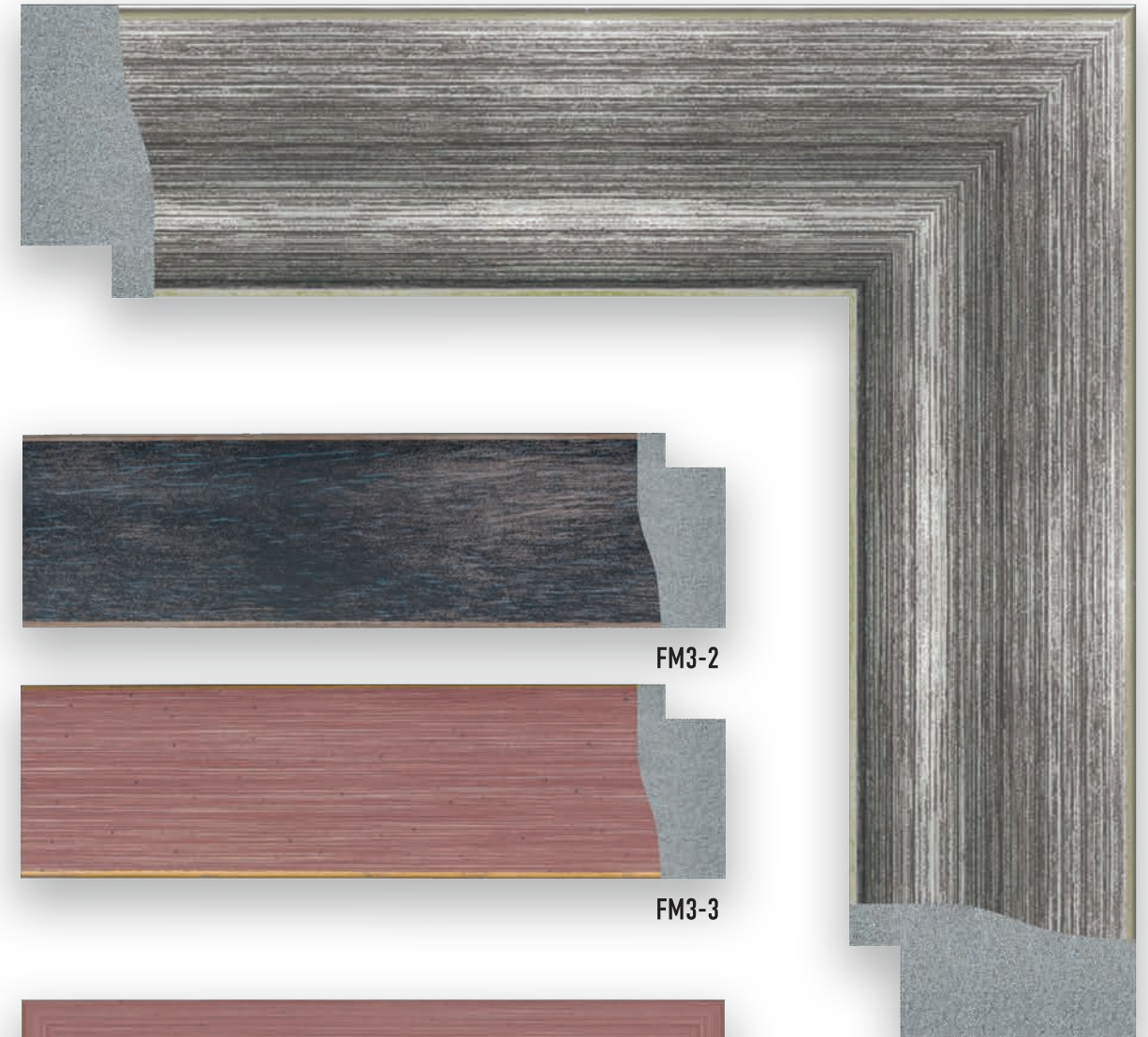
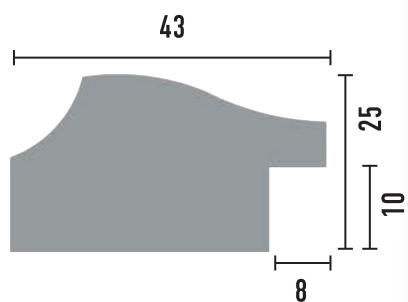

FM3-2



FM3-3

FM3-1

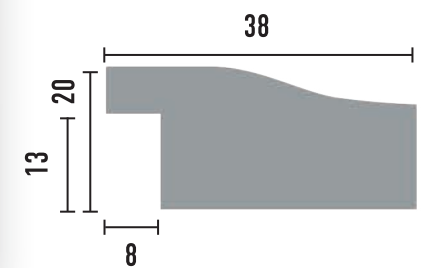



Длина: 2850 мм

Длина: 2850 мм



FM16-2

FM16-1

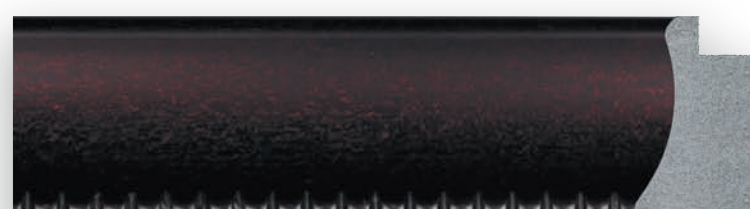
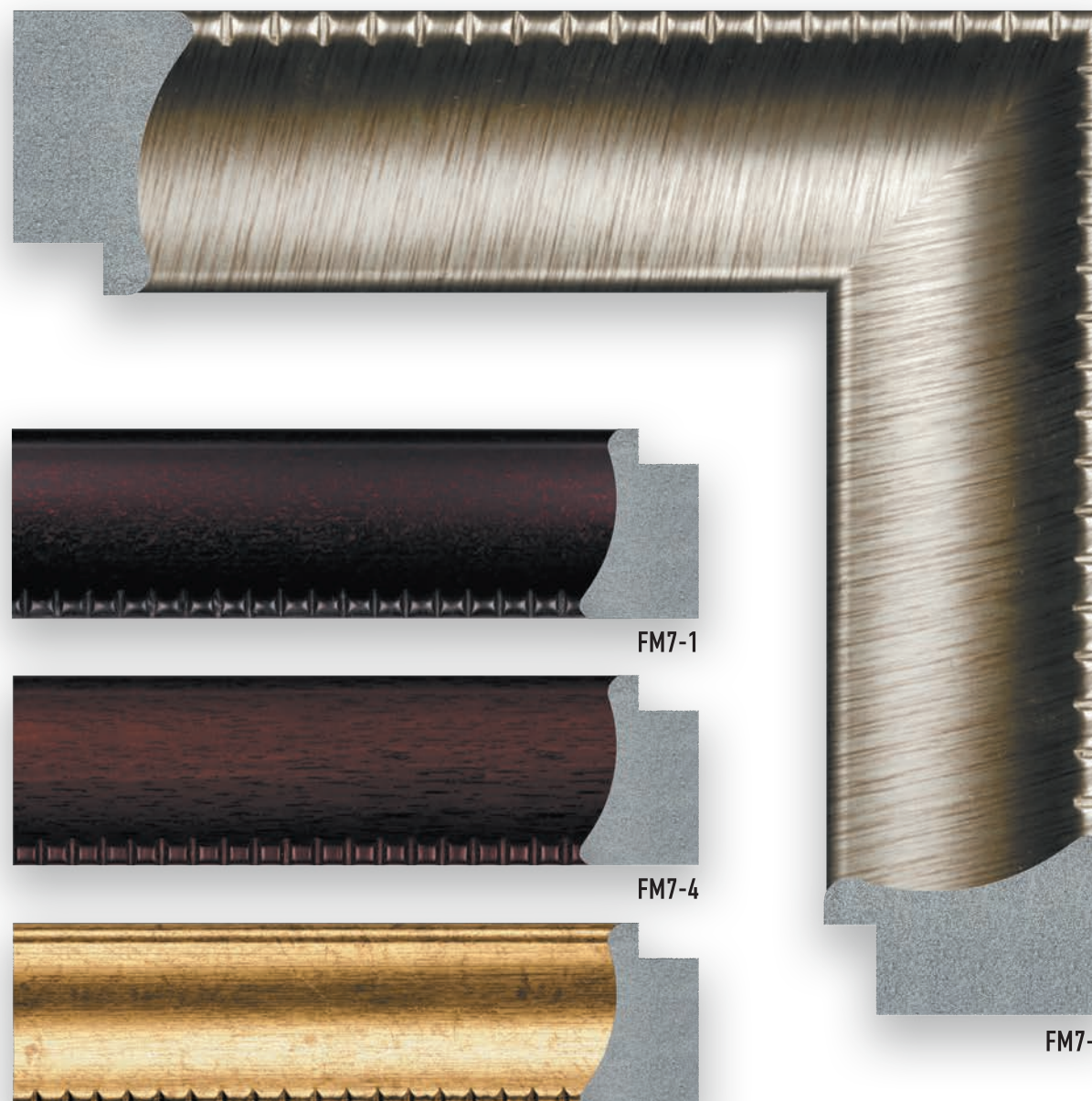
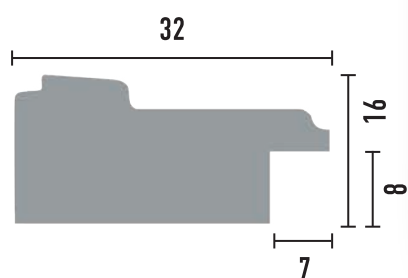

FM7-1

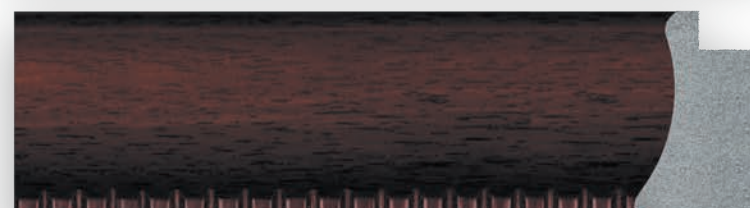

FM7-4



FM7-2

FM7-3

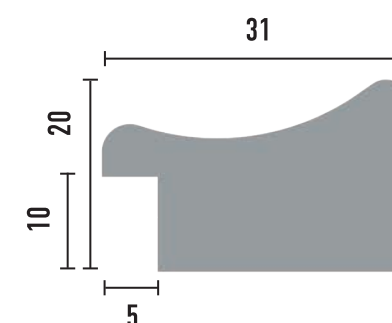





Длина: 2850 мм



FM2-1

FM2-3

FM2-2

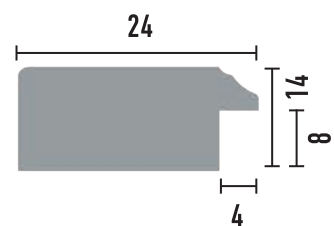

Длина: 2850 мм

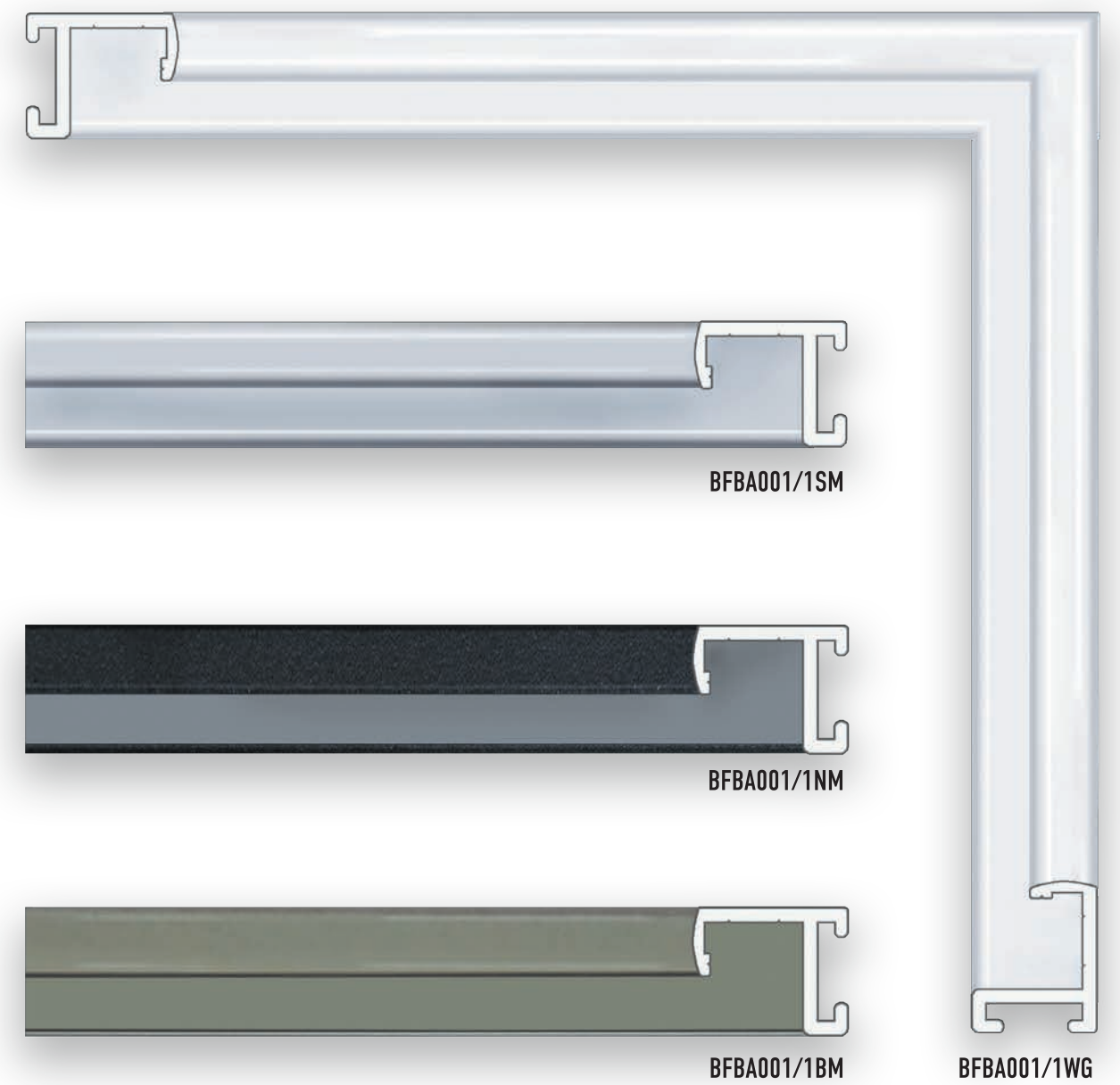

BFBA001/1SM

BFBA001/1NM

BFBA001/1BM

BFBA001/1WG

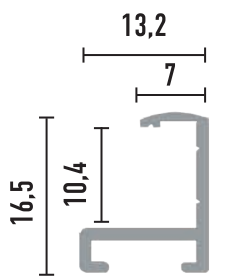





Обращаем внимание на то, что цвет готового изделия может отличаться от цвета материалов в каталоге, что связано с искажением цветопередачи в процессе печати каталога. Мы рекомендуем вам делать свой выбор по образцам, представленным в наших торговых точках. Отраслевая специфика производства продукции допускает незначительные отклонения в цветовой гамме отгружаемых изделий от выставочных образцов и в разных партиях выпуска.

# СОДЕРЖАНИЕ

Артикул	Стр.	Артикул	Стр.	Артикул	Стр.	Артикул	Стр.	Артикул	Стр.	Артикул	Стр.	Артикул	Стр.
102-15	68	158-552	72	413-1608	16	556-6	50	807-40	58	BFBA001/1NM	109	FM20-1	104
102-17	69	158-553	72	413-1609	16	564-277	66	807-41	58	FM2-1	108	FM20-2	104
102-18	68	158-6	71	477-114	55	564-278	66	807-42	58	FM2-2	108	FM21-1	91
102-19	68	158-7D	71	477-1243	55	564-280	66	807-43	58	FM2-3	108	FM21-2	91
102-20	68	158-767	72	477-1244	55	566-1606	38	807-44	58	FM3-1	105	FM22-1	80
102-28	69	158-933	71	477-195	55	566-1607	38	807-5	56	FM3-2	105	FM22-2	80
102-29	69	158-937	71	516-126	23	566-1608	38	807-56	57	FM3-3	105	FM22-3	80
102-51	69	159B-565	77	516-127	23	566-1609	38	807-57	57	FM4-1	85	FM22-4	80
102-52	69	159D-552	78	516-1069	22	566-1223	38	807-58	57	FM4-2	85	FM23-1	99
108-7	35	175-1	47	516-1070	23	566-1224	38	807-59	59	FM4-3	85	FM24-1	88
108-1333	35	175-2	47	516-1333	22	577-1223	37	807-552	58	FM4-4	85	FM25-1	87
108-1069	35	175-3	47	516-767	23	577-966	37	807-553	58	FM5-1	102	FM25-2	87
108-17	36	175-4	47	524-1069	40	582-26	33	807-6	56	FM5-2	102	FM25-3	87
108-18	36	175-5	47	524-1070	40	582-27	33	807-60	59	FM5-3	102	FM25-4	87
108-19	36	175-6	47	524-1333	40	582-433	33	807-63	59	FM5-4	102	FM26-1	83
108-20	36	176-1	41	527-114	30	582-438	33	807-966	57	FM6-1	103	FM26-2	83
108-28	36	176-2	41	527-1243	30	583-22	70	807-7D	56	FM6-2	103	FM27-1	95
108-29	36	176-3	41	527-1244	30	583-28	70	808-552	44	FM7-1	107	FM28-1	82
109-11	60	176-4	41	527-195	30	583-29	70	808-553	44	FM7-2	107	FM28-2	82
109-17	61	176-5	41	527-725	30	584-1333	67	811M-905	34	FM7-3	107	FM29-1	86
109-18	61	176-6	41	528-114	53	584-1069	67	811M-906	34	FM7-4	107	FM29-2	86
109-19	61	214-3	12	528-1243	53	584-1070	67	829-294	42	FM8-1	84	FM29-3	86
109-20	61	214-373	12	528-1244	53	587-70	45	829-934	42	FM8-2	84	FM29-4	86
109-28	61	214-6	12	528-195	53	587-1604	45	829-935	42	FM9-1	81	FM30-1	98
109-29	61	229-182	9	534-11	64	587-1604B	45	849-373	20	FM9-2	81	FM30-2	98
117-438	76	229-1068	9	534-13	64	587-1605	45	849-565	20	FM9-3	81	FM30-3	98
117-552	76	229-1223	8	534-14	64	587-1605B	45	849-566	20	FM9-4	81	FM30-4	98
117-553	76	229-645	8	534-15	64	611-195	46	849-919	19	FM9-5	81	FM31-1	93
118-17	79	229-955	8	534-51	64	611-1607	46	868-645	21	FM10-1	92	J11-115	51
118-18	79	229-966	8	534-52	64	611-1608	46	916-247	11	FM10-2	92	J11-966	51
118-19	79	230-70	6	534-53	64	611-1610	46	916-393	11	FM10-3	92	J11-1223	51
118-20	79	230-1223	6	548M-440	48	651-176	65	916-397	11	FM10-4	92	J11-1224	51
118-29	79	230-966	6	552-114	24	651-176S	65	916-461	11	FM10-5	92	J12-1224	63
119-34	74	230-1543	6	552-1153	24	685-126	62	919-70	31	FM11-1	89	J13-1223	54
119-37	74	230-1604B	6	552-195	24	685-127	62	919-1604	31	FM11-2	89	J13-1224	54
149-954	75	230-1605B	6	552-373	24	685-182	62	919-1604B	31	FM12-1	100	J13-966	54
149-956	75	230-1610	6	552D-114	27	685-217	62	919-1605	31	FM12-2	100	S16-1223	5
158-1	71	293-752	18	552D-195	27	685-221	62	919-1605B	31	FM14-1	90	S16-966	5
158-1028	73	304-126	43	552C-114	26	686M-565	52	927-252	17	FM15-1	97	S18-1223	28
158-1084	72	304-127	43	552C-195	26	690-182	39	947-565	4	FM15-2	97	S18-1224	28
158-115	72	400-954	10	552B-1606	25	690-198	39	947-566	4	FM16-1	106	S18-966	28
158-118	73	400-956	10	552B-1607	25	696-182	29	947-954	4	FM16-2	106	S26-70	13
158-126	73	400-958	10	552B-1608	25	696-401	29	947-956	4	FM17-1	96	S26-1604B	13
158-127	73	413-182	15	552B-1609	25	807-1	56	978-565	32	FM17-2	96	S26-1605B	13
158-281	73	413-494	14	553-114	49	807-1223	57	978-566	32	FM18-1	101		
158-3	71	413-565	14	553-1153	49	807-18D	59	980-565	7	FM18-2	101		
158-4	71	413-566	14	553-195	49	807-19D	59	980-566	7	FM18-3	101		
158-5	71	413-919	14	553-373	49	807-2	56	BFBAA001/TWG	109	FM18-4	101		
158-54	72	413-1606	16	556-2	50	807-3	56	BFBAA001/1BM	109	FM19-1	94		
158-55	70	413-1607	16	556-4	50	807-4	56	BFBAA001/1SM	109	FM19-2	94		



